



FLIESENPROFILE

Für Abschlüsse - Dekoration - Übergang - Wand/Boden - Eckschutz



1. Vorteil
Anwendungsvielfalt
 Für jede Wand-Boden-Anwendung das richtige Profil. Verfügbar für Belagsstärken von 2 – 30 mm. Ausgesuchte Profilsortimente in Länge 100 cm, 250 cm und 300 cm verfügbar.

2. Vorteil
Materialvielfalt
 Profilsysteme für Fliesenbeläge in Materialausführung Aluminium, Edelstahl V2A/V4A, Messing und PVC lieferbar.

3. Vorteil
DURAL COLOUR FITTING
 Durchgängige Farbkonzepte, die sich in vielen Profilsortimenten wiederfinden - achten Sie auf das Logo.

DURAPLUS DIAMOND Abschlussprofil

Profilserie mit 45° Diamant-Cut für ein Fliesenfinish mit besonderer Optik und Haptik
 Material: Aluminium eloxiert, pulverbeschichtet

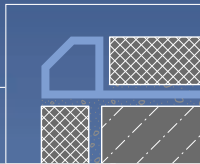

VE1	VE2	VE3	Kat.
10	40	-	A

Höhe mm	Länge cm	Farbe	Referenz	€/lfm
---------	----------	-------	----------	-------

eloxiert

9	250	silber	DPDAE 90/250	13,16
10	250	silber	DPDAE 100/250	13,62
11	250	silber	DPDAE 110/250	14,04

pulverbeschichtet

9	250	RAL 9011 schwarz matt	DPDACM 911/250	14,62
10	250	RAL 9011 schwarz matt	DPDACM 1011/250	15,42
11	250	RAL 9011 schwarz matt	DPDACM 1111/250	16,30

eloxiert

9	300	silber	DPDAE 90/300	13,16
10	300	silber	DPDAE 100/300	13,62
11	300	silber	DPDAE 110/300	14,04

pulverbeschichtet

9	300	RAL 9011 schwarz matt	DPDACM 911/300	14,62
10	300	RAL 9011 schwarz matt	DPDACM 1011/300	15,42
11	300	RAL 9011 schwarz matt	DPDACM 1111/300	16,30

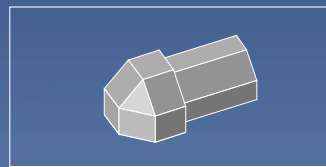

Referenz	Stück/Blister	€/Stück
----------	---------------	---------

Material: Metalldruckguss

DPDAE 90-Y ECO/2	2	4,66
DPDAE 100-Y ECO/2	2	4,66
DPDAE 110-Y ECO/2	2	4,66

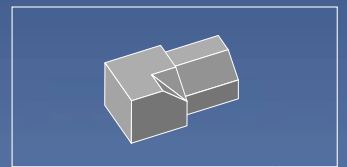

Referenz	Stück/Blister	€/Stück
----------	---------------	---------

Material: Metalldruckguss

DPDACM 911-Y ECO/2	2	5,18
DPDACM 1011-Y ECO/2	2	5,18
DPDACM 1111-Y ECO/2	2	5,18

DPDACM 911-YI ECO/2	2	5,18
DPDACM 1011-YI ECO/2	2	5,18
DPDACM 1111-YI ECO/2	2	5,18

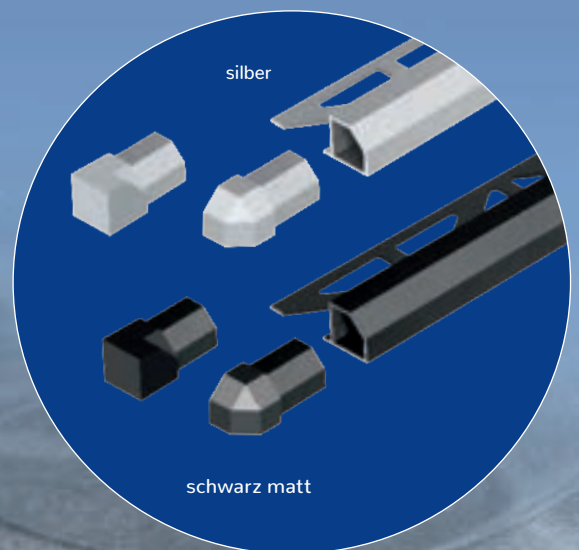



DURAPLUS DIAMOND

Abschlussprofil

Profilserie mit 45° Diamant-Cut für ein Fliesenfinish mit besonderer Optik und Haptik

Material: Aluminium pulverbeschichtet

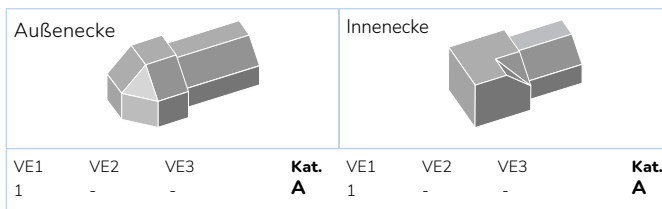
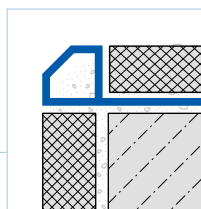

VE1	VE2	VE3	Kat.
10	40	-	A

VE1	VE2	VE3	Kat.
1	-	-	A

Höhe mm	Länge cm	Farbe	Referenz	€/lfm
---------	----------	-------	----------	-------

pulverbeschichtet

9	250	RAL 0808005 sand	DPDAC 980/250	14,62
10	250	RAL 0808005 sand	DPDAC 1080/250	15,42
11	250	RAL 0808005 sand	DPDAC 1180/250	16,30

9	250	RAL 0006500 betongrau	DPDAC 965/250	14,62
10	250	RAL 0006500 betongrau	DPDAC 1065/250	15,42
11	250	RAL 0006500 betongrau	DPDAC 1165/250	16,30

pulverbeschichtet

9	300	RAL 0808005 sand	DPDAC 980/300	14,62
10	300	RAL 0808005 sand	DPDAC 1080/300	15,42
11	300	RAL 0808005 sand	DPDAC 1180/300	16,30

9	300	RAL 0006500 betongrau	DPDAC 965/300	14,62
10	300	RAL 0006500 betongrau	DPDAC 1065/300	15,42
11	300	RAL 0006500 betongrau	DPDAC 1165/300	16,30

Referenz	Stück/Blister	€/Stück	Referenz	Stück/Blister	€/Stück
----------	---------------	---------	----------	---------------	---------

Material: Metalldruckguss

DPDAC 980-Y ECO/2	2	5,18	DPDAC 980-YI ECO/2	2	5,18
DPDAC 1080-Y ECO/2	2	5,18	DPDAC 1080-YI ECO/2	2	5,18
DPDAC 1180-Y ECO/2	2	5,18	DPDAC 1180-YI ECO/2	2	5,18

DPDAC 965-Y ECO/2	2	5,18	DPDAC 965-YI ECO/2	2	5,18
DPDAC 1065-Y ECO/2	2	5,18	DPDAC 1065-YI ECO/2	2	5,18
DPDAC 1165-Y ECO/2	2	5,18	DPDAC 1165-YI ECO/2	2	5,18



SQUARELINE ab Seite 12
DUROSOL ab Seite 22
DURONDELL ab Seite 32
myVARIO-LINE ab Seite 119
SHOWER-GK ab Seite 124
TI-SHELF ab Seite 132





DURAPLUS Messing

Rechteck-Abschlussprofil für Wand und Boden

Material: Messing

Sichtbreite 8 mm

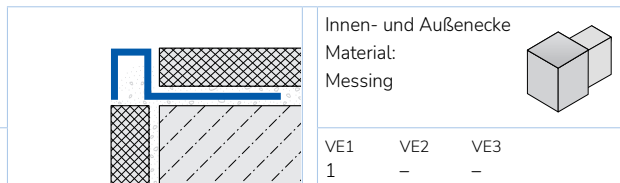

Höhe mm	Länge cm	Material	Oberfläche	Referenz	€/lfm	Referenz	Stück/Blister	€/Stück
9	250	Messing	natur	DPM 90/250	30,46	DPM 90-Y/1	1	34,66
11	250	Messing	natur	DPM 110/250	32,68	DPM 110-Y/1	1	34,66
12,5	250	Messing	natur	DPM 125/250	34,56	DPM 125-Y/1	1	34,66
9	250	Messing	hochglänzend mit Schutzfolie	DPM 90-SP/250	43,58	DPM 90-SP-Y/1	1	50,56
11	250	Messing	hochglänzend mit Schutzfolie	DPM 110-SP/250	45,96	DPM 110-SP-Y/1	1	50,56
12,5	250	Messing	hochglänzend mit Schutzfolie	DPM 125-SP/250	47,40	DPM 125-SP-Y/1	1	50,56
9	250	Messing	verchromt	DPM 90-SC/250	51,32	DPM 90-SC-Y/1	1	60,54
11	250	Messing	verchromt	DPM 110-SC/250	53,18	DPM 110-SC-Y/1	1	60,54
12,5	250	Messing	verchromt	DPM 125-SC/250	54,90	DPM 125-SC-Y/1	1	60,54





SQUARELINE

Quadratisches Abschlussprofil für
 Wand und Boden
 Material: Aluminium pulverbeschichtet

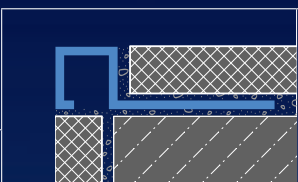

Innen- und Außenecke
 Material:
 Aluminium
 pulverbeschichtet



VE1	VE2	VE3	Kat.
10	40	-	A

VE1	VE2	VE3
1	-	-

Höhe mm	Länge cm	Farbe	Referenz	€/lfm	Referenz	Stück/Blister	€/Stück
---------	----------	-------	----------	-------	----------	---------------	---------

Oberfläche: pulverbeschichtet

9	250	RAL 0808005 sand	DPSAC 980/250	13,32	DPSAC 980-Y ECO/2	2	7,00
11	250	RAL 0808005 sand	DPSAC 1180/250	15,98	DPSAC 1180-Y ECO/2	2	7,00
9	250	RAL 0006500 betongrau	DPSAC 965/250	13,32	DPSAC 965-Y ECO/2	2	7,00
11	250	RAL 0006500 betongrau	DPSAC 1165/250	15,98	DPSAC 1165-Y ECO/2	2	7,00
7	250	RAL 9011 schwarz matt	DPSACM 711/250	11,10	DPSACM 711-Y/2	2	7,00
9	250	RAL 9011 schwarz matt	DPSACM 911/250	13,32	DPSACM 911-Y/2	2	7,00
11	250	RAL 9011 schwarz matt	DPSACM 1111/250	15,98	DPSACM 1111-Y/2	2	7,00

Blister 2 Stück

9	300	RAL 0808005 sand	DPSAC 980/300	13,32			
11	300	RAL 0808005 sand	DPSAC 1180/300	15,98			
9	300	RAL 0006500 betongrau	DPSAC 965/300	13,32			
11	300	RAL 0006500 betongrau	DPSAC 1165/300	15,98			
7	300	RAL 9011 schwarz matt	DPSACM 711/300	11,10			
9	300	RAL 9011 schwarz matt	DPSACM 911/300	13,32			
11	300	RAL 9011 schwarz matt	DPSACM 1111/300	15,98			

Beutel 20 Stück

DPSACM 1111-Y/20	20	4,92
------------------	----	------

DURAPLUS

DIAMOND ab Seite 9

DUROSOL ab Seite 22

DURONDELL ab Seite 32

myVARIO-LINE ab Seite 119

SHOWER-GK ab Seite 124

TI-SHELF ab Seite 132

DURAL
COLOUR
 FITTING

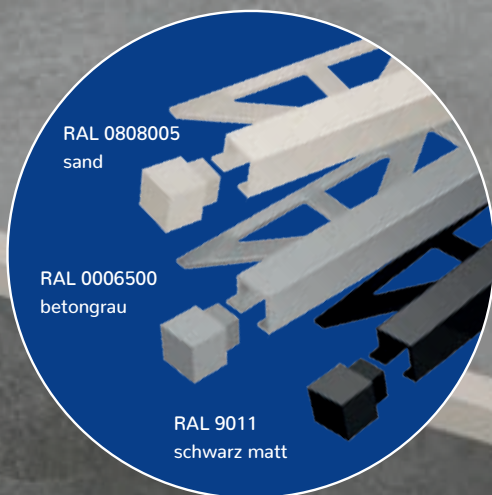



SQUARELINE Aluminium strukturbeschichtet

Quadratisches Abschlussprofil für
 Wandflächen
 Material: Aluminium

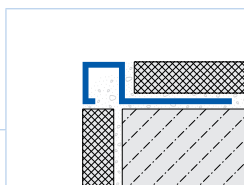

Innen- und Außenecke

Material:
 Aluminium
 strukturbeschichtet



VE1	VE2	VE3	Kat. A
10	40	-	

VE1	VE2	VE3
1	-	-

Höhe mm	Länge cm	Farbe	Referenz	€/l _{fm}	Referenz	Stück/ Blister	€/Stück
------------	-------------	-------	----------	-------------------	----------	-------------------	---------

Oberfläche: strukturbeschichtet

7	250	beige strukturbeschichtet	DPSACS 732/250	17,36	DPSACS 732-Y/2	2	7,90
9	250	beige strukturbeschichtet	DPSACS 932/250	18,10	DPSACS 932-Y/2	2	7,90
10	250	beige strukturbeschichtet	DPSACS 1032/250	19,76	DPSACS 1032-Y/2	2	7,90
11	250	beige strukturbeschichtet	DPSACS 1132/250	20,46	DPSACS 1132-Y/2	2	7,90
12,5	250	beige strukturbeschichtet	DPSACS 1232/250	22,10	DPSACS 1232-Y/2	2	7,90

7	250	braun strukturbeschichtet	DPSACS 735/250	17,36	DPSACS 735-Y/2	2	7,90
9	250	braun strukturbeschichtet	DPSACS 935/250	18,10	DPSACS 935-Y/2	2	7,90
10	250	braun strukturbeschichtet	DPSACS 1035/250	19,76	DPSACS 1035-Y/2	2	7,90
11	250	braun strukturbeschichtet	DPSACS 1135/250	20,46	DPSACS 1135-Y/2	2	7,90
12,5	250	braun strukturbeschichtet	DPSACS 1235/250	22,10	DPSACS 1235-Y/2	2	7,90

7	250	anthrazit strukturbeschichtet	DPSACS 733/250	17,36	DPSACS 733-Y/2	2	7,90
9	250	anthrazit strukturbeschichtet	DPSACS 933/250	18,10	DPSACS 933-Y/2	2	7,90
10	250	anthrazit strukturbeschichtet	DPSACS 1033/250	19,76	DPSACS 1033-Y/2	2	7,90
11	250	anthrazit strukturbeschichtet	DPSACS 1133/250	20,46	DPSACS 1133-Y/2	2	7,90
12,5	250	anthrazit strukturbeschichtet	DPSACS 1233/250	22,10	DPSACS 1233-Y/2	2	7,90

Neue
 Höhen
 7/9/10/12,5
 mm

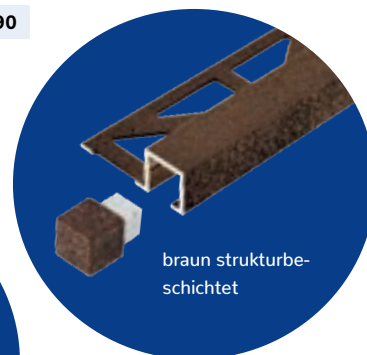



SQUARELINE Aluminium

Quadratisches Abschlussprofil
 für Wand und Boden
 Material: Aluminium hochglanzeloxiert

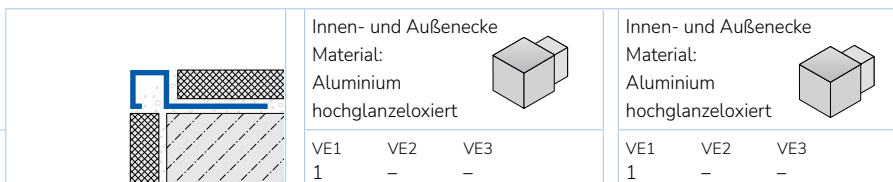

VE1 10	VE2 40	VE3 -	Kat. AA	Referenz	€/lfm	Referenz	Stück/ Blister	€/Stück	Referenz	Stück/ Beutel	€/Stück
1	-	-									

Oberfläche: hochglanzeloxiert

Höhe mm	Länge cm	Farbe	Oberfläche	Referenz	€/lfm	Referenz	Stück/Blister	€/Stück	Referenz	Stück/Beutel	€/Stück
7	250	silber	hochglanzeloxiert	DPSA 762/250	16,38	DPSA 762-Y/2	2	5,77	DPSA 762-Y/20	20	5,20
9	250	silber	hochglanzeloxiert	DPSA 962/250	17,80	DPSA 962-Y/2	2	5,77	DPSA 962-Y/20	20	5,20
10	250	silber	hochglanzeloxiert	DPSA 1062/250	18,64	DPSA 1062-Y/2	2	5,77	DPSA 1062-Y/20	20	5,20
11	250	silber	hochglanzeloxiert	DPSA 1162/250	19,36	DPSA 1162-Y/2	2	5,77	DPSA 1162-Y/20	20	5,20
12,5	250	silber	hochglanzeloxiert	DPSA 1262/250	20,84	DPSA 1262-Y/2	2	5,77	DPSA 1262-Y/20	20	5,20
7	250	gold	hochglanzeloxiert	DPSA 761/250	17,14	DPSA 761-Y/2	2	6,08	DPSA 761-Y/20	20	4,84
9	250	gold	hochglanzeloxiert	DPSA 961/250	18,68	DPSA 961-Y/2	2	6,08	DPSA 961-Y/20	20	4,84
10	250	gold	hochglanzeloxiert	DPSA 1061/250	19,46	DPSA 1061-Y/2	2	6,08			
11	250	gold	hochglanzeloxiert	DPSA 1161/250	20,28	DPSA 1161-Y/2	2	6,08	DPSA 1161-Y/20	20	4,84
12,5	250	gold	hochglanzeloxiert	DPSA 1261/250	21,86	DPSA 1261-Y/2	2	6,08	DPSA 1261-Y/20	20	4,84
7	250	titan	hochglanzeloxiert	DPSA 763/250	16,38	DPSA 763-Y/2	2	6,08			
9	250	titan	hochglanzeloxiert	DPSA 963/250	18,40	DPSA 963-Y/2	2	6,08			
10	250	titan	hochglanzeloxiert	DPSA 1063/250	19,36	DPSA 1063-Y/2	2	6,08	DPSA 1063-Y/20	20	4,84
11	250	titan	hochglanzeloxiert	DPSA 1163/250	20,28	DPSA 1163-Y/2	2	6,08			
12,5	250	titan	hochglanzeloxiert	DPSA 1263/250	21,86	DPSA 1263-Y/2	2	6,08			





SQUARELINE Aluminium

Quadratisches Abschlussprofil für Wand und Boden
 Material: Aluminium hochglanzeloxiert gebürstet

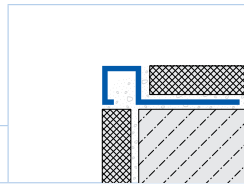

Innen- und Außenecke
 Material: Aluminium hochglanzeloxiert gebürstet



Innen- und Außenecke
 Material: Aluminium hochglanzeloxiert gebürstet



VE1	VE2	VE3	Kat.	Höhe mm	Länge cm	Farbe	Oberfläche	Referenz	€/lfm	Referenz	Stück/Blister	€/Stück	Referenz	Stück/Beutel	€/Stück
10	40	-	AA												
1	-	-													
1	-	-													

Oberfläche: hochglanzeloxiert gebürstet

7	250	silber	hochglanzeloxiert gebürstet	DPSA 762-SF/250	19,74	DPSA 762-SF-Y/2	2	8,29	DPSA 762-SF-Y/20	20	7,34
9	250	silber	hochglanzeloxiert gebürstet	DPSA 962-SF/250	21,38	DPSA 962-SF-Y/2	2	8,29	DPSA 962-SF-Y/20	20	7,34
10	250	silber	hochglanzeloxiert gebürstet	DPSA 1062-SF/250	22,32	DPSA 1062-SF-Y/2	2	8,29	DPSA 1062-SF-Y/20	20	7,34
11	250	silber	hochglanzeloxiert gebürstet	DPSA 1162-SF/250	23,18	DPSA 1162-SF-Y/2	2	8,29	DPSA 1162-SF-Y/20	20	7,34
12,5	250	silber	hochglanzeloxiert gebürstet	DPSA 1262-SF/250	25,00	DPSA 1262-SF-Y/2	2	8,29	DPSA 1262-SF-Y/20	20	7,34
7	250	titan	hochglanzeloxiert gebürstet	DPSA 763-SF/250	20,76	DPSA 763-SF-Y/2	2	8,29	DPSA 763-SF-Y/20	20	7,34
9	250	titan	hochglanzeloxiert gebürstet	DPSA 963-SF/250	22,42	DPSA 963-SF-Y/2	2	8,29	DPSA 963-SF-Y/20	20	7,34
10	250	titan	hochglanzeloxiert gebürstet	DPSA 1063-SF/250	22,82	DPSA 1063-SF-Y/2	2	8,29	DPSA 1063-SF-Y/20	20	7,34
11	250	titan	hochglanzeloxiert gebürstet	DPSA 1163-SF/250	23,18	DPSA 1163-SF-Y/2	2	8,29	DPSA 1163-SF-Y/20	20	7,34
12,5	250	titan	hochglanzeloxiert gebürstet	DPSA 1263-SF/250	26,22	DPSA 1263-SF-Y/2	2	8,29	DPSA 1263-SF-Y/20	20	7,34

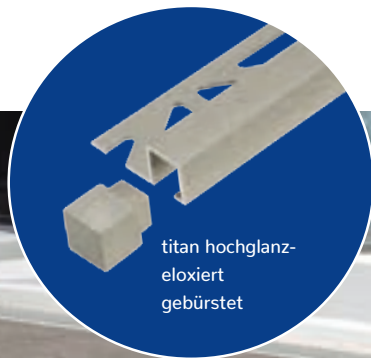
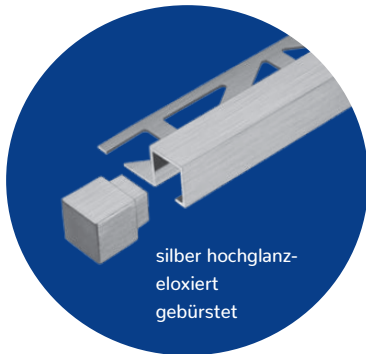

VE1	VE2	VE3
1	-	-

Höhe mm	Farbe	Referenz	Stück/Blister	€/Stück
---------	-------	----------	---------------	---------

Material: Metalldruckguss; Oberfläche: gebürstet

10	silber	DPSA 1062-SF-Y ECO/2	2	7,78
11	silber	DPSA 1162-SF-Y ECO/2	2	7,78
12,5	silber	DPSA 1262-SF-Y ECO/2	2	7,78
10	titan	DPSA 1063-SF-Y ECO/2	2	7,78
11	titan	DPSA 1163-SF-Y ECO/2	2	7,78
12,5	titan	DPSA 1263-SF-Y ECO/2	2	7,78





SQUARELINE Aluminium

Quadratisches Abschlussprofil für Wand und Boden; Material: Aluminium natur/eloxiert

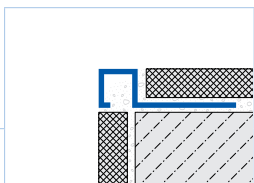

Innen- und Außenecke

Material:
Aluminium
natur/eloxiert



Innen- und Außenecke

Material:
Aluminium
natur/eloxiert



VE1	VE2	VE3	Kat. A
10	40	-	

VE1	VE2	VE3
1	-	-

VE1	VE2	VE3
1	-	-

Höhe mm	Länge cm	Farbe	Oberfläche	Referenz	€/lfm	Referenz	Stück/Blister	€/Stück	Referenz	Stück/Beutel	€/Stück
---------	----------	-------	------------	----------	-------	----------	---------------	---------	----------	--------------	---------

Oberfläche: natur/eloxiert

7	250	natur		DPSA 70/250	8,48
9	250	natur		DPSA 90/250	8,80
10	250	natur		DPSA 100/250	9,04
11	250	natur		DPSA 110/250	9,20
12,5	250	natur		DPSA 125/250	9,98

7	250	silber	eloxiert	DPSAE 70/250	11,02
9	250	silber	eloxiert	DPSAE 90/250	11,54
10	250	silber	eloxiert	DPSAE 100/250	11,90
11	250	silber	eloxiert	DPSAE 110/250	12,24
12,5	250	silber	eloxiert	DPSAE 125/250	13,36

7	250	titan	eloxiert	DPSAE 70-T/250	11,54
9	250	titan	eloxiert	DPSAE 90-T/250	12,16
10	250	titan	eloxiert	DPSAE 100-T/250	12,54
11	250	titan	eloxiert	DPSAE 110-T/250	12,82
12,5	250	titan	eloxiert	DPSAE 125-T/250	13,96

9	300	silber	eloxiert	DPSAE 90/300	11,54
10	300	silber	eloxiert	DPSAE 100/300	11,90
11	300	silber	eloxiert	DPSAE 110/300	12,24
12,5	300	silber	eloxiert	DPSAE 125/300	13,36

9	300	titan	eloxiert	DPSAE 90-T/300	12,16
11	300	titan	eloxiert	DPSAE 110-T/300	12,82

DPSAE 70-Y/2	2	5,17	DPSAE 70-Y/20	20	4,66
DPSAE 90-Y/2	2	5,17	DPSAE 90-Y/20	20	4,66
DPSAE 100-Y/2	2	5,17	DPSAE 100-Y/20	20	4,66
DPSAE 110-Y/2	2	5,17	DPSAE 110-Y/20	20	4,66
DPSAE 125-Y/2	2	5,17	DPSAE 125-Y/20	20	4,66

DPSAE 70-T-Y/2	2	5,41	DPSAE 70-T-Y/20	20	4,92
DPSAE 90-T-Y/2	2	5,41	DPSAE 90-T-Y/20	20	4,92
DPSAE 100-T-Y/2	2	5,41	DPSAE 100-T-Y/20	20	4,92
DPSAE 110-T-Y/2	2	5,41	DPSAE 110-T-Y/20	20	4,92
DPSAE 125-T-Y/2	2	5,41	DPSAE 125-T-Y/20	20	4,92

Länge
3 m



Innen- und Außenecke			
VE1	VE2	VE3	
1	-	-	

Höhe mm	Farbe	Referenz	Stück/Blister	€/Stück
---------	-------	----------	---------------	---------

Material: Metalldruckguss; Oberfläche: matt

9	silber	DPSAE 90-Y ECO/2	2	3,82
10	silber	DPSAE 100-Y ECO/2	2	3,82
11	silber	DPSAE 110-Y ECO/2	2	3,82
12,5	silber	DPSAE 125-Y ECO/2	2	3,82
10	titan	DPSAE 100-T-Y ECO/2	2	4,05
11	titan	DPSAE 110-T-Y ECO/2	2	4,05
12,5	titan	DPSAE 125-T-Y ECO/2	2	4,05



Höhe mm	Farbe	Referenz	Stück/Beutel	€/Stück
9	silber	DPSAE 90-Y ECO/20	20	3,52
11	silber	DPSAE 110-Y ECO/20	20	3,52



SQUARELINE Edelstahl (V2A/304)

Quadratisches Abschlussprofil für Wand und Boden

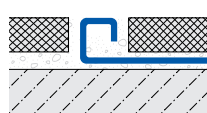
Material: Edelstahl (V2A/304)

 	Innen- und Außenecke Material: Edelstahl (V2A/304)						Innen- und Außenecke Material: Edelstahl (V2A/304)							
	VE1	VE2	VE3	VE1	VE2	VE3	1	-	-	VE1	VE2	VE3	1	-

Höhe mm	Länge cm	Farbe	Oberfläche	Referenz	€/lfm	Referenz	Stück/Blister	€/Stück	Referenz	Stück/Beutel	€/Stück
---------	----------	-------	------------	----------	-------	----------	---------------	---------	----------	--------------	---------

Material: Edelstahl (V2A/304) natur

7	250	natur		DPSE 70/250 Neu	23,64	DPSE 70-Y/1 Neu	1	22,98	DPSE 70-Y/20 Neu	20	18,64
9	250	natur		DPSE 90/250	25,04	DPSE 90-Y/1	1	22,98	DPSE 90-Y/20	20	18,64
10	250	natur		DPSE 100/250	25,86	DPSE 100-Y/1	1	22,98	DPSE 100-Y/20	20	18,64
11	250	natur		DPSE 110/250	26,74	DPSE 110-Y/1	1	22,98	DPSE 110-Y/20	20	18,64
12,5	250	natur		DPSE 125/250	28,64	DPSE 125-Y/1	1	22,98	DPSE 125-Y/20	20	18,64

Material: Edelstahl (V2A/304) hochglanzpoliert mit Schutzfolie



7	250	natur	hochglanzpoliert mit Schutzfolie	Neu DPSE 70-SP/250	25,60	Neu DPSE 70-SP-Y/1	1	27,92	Neu DPSE 70-SP-Y/20	20	22,52
9	250	natur	hochglanzpoliert mit Schutzfolie	DPSE 90-SP/250	25,98	DPSE 90-SP-Y/1	1	27,92	DPSE 90-SP-Y/20	20	22,52
10	250	natur	hochglanzpoliert mit Schutzfolie	DPSE 100-SP/250	26,32	DPSE 100-SP-Y/1	1	27,92	DPSE 100-SP-Y/20	20	22,52
11	250	natur	hochglanzpoliert mit Schutzfolie	DPSE 110-SP/250	27,40	DPSE 110-SP-Y/1	1	27,92	DPSE 110-SP-Y/20	20	22,52
12,5	250	natur	hochglanzpoliert mit Schutzfolie	DPSE 125-SP/250	28,94	DPSE 125-SP-Y/1	1	27,92	DPSE 125-SP-Y/20	20	22,52

Material: Edelstahl (V2A/304) Feinschliff mit Schutzfolie

7	250	natur	Feinschliff mit Schutzfolie	Neu DPSE 70-SF/250	28,62	Neu DPSE 70-SF-Y/1	1	29,88	Neu DPSE 70-SF-Y/20	20	23,98
9	250	natur	Feinschliff mit Schutzfolie	DPSE 90-SF/250	29,60	DPSE 90-SF-Y/1	1	29,88	DPSE 90-SF-Y/20	20	23,98
10	250	natur	Feinschliff mit Schutzfolie	DPSE 100-SF/250	30,60	DPSE 100-SF-Y/1	1	29,88	DPSE 100-SF-Y/20	20	23,98
11	250	natur	Feinschliff mit Schutzfolie	DPSE 110-SF/250	31,52	DPSE 110-SF-Y/1	1	29,88	DPSE 110-SF-Y/20	20	23,98
12,5	250	natur	Feinschliff mit Schutzfolie	DPSE 125-SF/250	34,16	DPSE 125-SF-Y/1	1	29,88	DPSE 125-SF-Y/20	20	23,98

Neue Höhe 7 mm

Material: Metalldruckguss

Innen- und Außenecke			Innen- und Außenecke		
					
VE1	VE2	VE3	VE1	VE2	VE3
1	-	-	1	-	-

Höhe mm	Farbe	Oberfläche	Referenz	Stück/Blister	€/Stück	Referenz	Stück/Beutel	€/Stück
7	natur	Neu	DPSE 70-Y ECO/2	2	8,00	DPSE 70-Y ECO/20	20	5,86
9	natur		DPSE 90-Y ECO/2	2	8,00	DPSE 90-Y ECO/20	20	5,86
10	natur		DPSE 100-Y ECO/2	2	8,00	DPSE 100-Y ECO/20	20	5,86
11	natur		DPSE 110-Y ECO/2	2	8,00	DPSE 110-Y ECO/20	20	5,86
12,5	natur		DPSE 125-Y ECO/2	2	8,00	DPSE 125-Y ECO/20	20	5,86
7	natur	Feinschliff Neu	DPSE 70-SF-Y ECO/2	2	10,33	DPSE 70-SF-Y ECO/20	20	7,62
9	natur	Feinschliff	DPSE 90-SF-Y ECO/2	2	10,33	DPSE 90-SF-Y ECO/20	20	7,62
10	natur	Feinschliff	DPSE 100-SF-Y ECO/2	2	10,33	DPSE 100-SF-Y ECO/20	20	7,62
11	natur	Feinschliff	DPSE 110-SF-Y ECO/2	2	10,33	DPSE 110-SF-Y ECO/20	20	7,62
12,5	natur	Feinschliff	DPSE 125-SF-Y ECO/2	2	10,33	DPSE 125-SF-Y ECO/20	20	7,62

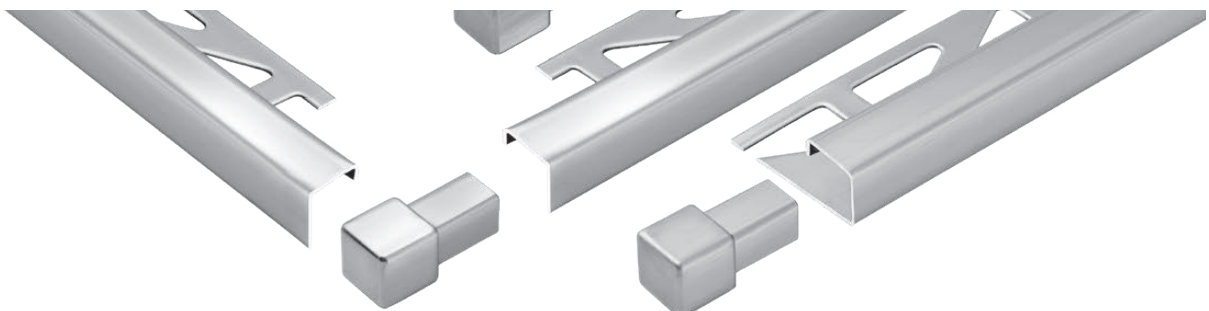



SQUARELINE Edelstahl (V2A/304)

Quadratisches Abschlussprofil für Wand und Boden

Material: Edelstahl (V2A/304)

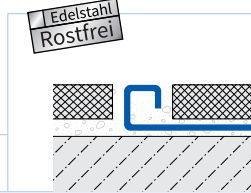

Innen- und Außenecke

Material:
Edelstahl (V2A/304)

VE1 VE2 VE3
1 - -

Innen- und Außenecke

Material:
Edelstahl (V2A/304)

VE1 VE2 VE3
1 - -

Höhe mm	Länge cm	Farbe	Oberfläche	Referenz	€/ lfm	Referenz	Stück/ Blister	€/ Blister	Referenz	Stück/ Beutel	€/ Stück
---------	----------	-------	------------	----------	--------	----------	----------------	------------	----------	---------------	----------

Material: Edelstahl (V2A/304)



9	300	natur		DPSE 90/300	25,04	DPSE 90-Y/1	1	22,98	DPSE 90-Y/20	20	18,64
10	300	natur		DPSE 100/300	25,86	DPSE 100-Y/1	1	22,98	DPSE 100-Y/20	20	18,64
11	300	natur		DPSE 110/300	26,74	DPSE 110-Y/1	1	22,98	DPSE 110-Y/20	20	18,64
12,5	300	natur		DPSE 125/300	28,66	DPSE 125-Y/1	1	22,98	DPSE 125-Y/20	20	18,64

Material: Edelstahl (V2A/304) hochglanzpoliert mit Schutzfolie

9	300	natur	hochglanzpoliert mit Schutzfolie	DPSE 90-SP/300	25,98	DPSE 90-SP-Y/1	1	27,92	DPSE 90-SP-Y/20	20	22,52
10	300	natur	hochglanzpoliert mit Schutzfolie	DPSE 100-SP/300	26,32	DPSE 100-SP-Y/1	1	27,92	DPSE 100-SP-Y/20	20	22,52
11	300	natur	hochglanzpoliert mit Schutzfolie	DPSE 110-SP/300	27,40	DPSE 110-SP-Y/1	1	27,92	DPSE 110-SP-Y/20	20	22,52
12,5	300	natur	hochglanzpoliert mit Schutzfolie	DPSE 125-SP/300	28,94	DPSE 125-SP-Y/1	1	27,92	DPSE 125-SP-Y/20	20	22,52

Material: Edelstahl (V2A/304) Feinschliff mit Schutzfolie

9	300	natur	Feinschliff mit Schutzfolie	DPSE 90-SF/300	29,60	DPSE 90-SF-Y/1	1	29,88	DPSE 90-SF-Y/20	20	23,98
10	300	natur	Feinschliff mit Schutzfolie	DPSE 100-SF/300	30,60	DPSE 100-SF-Y/1	1	29,88	DPSE 100-SF-Y/20	20	23,98
11	300	natur	Feinschliff mit Schutzfolie	DPSE 110-SF/300	31,52	DPSE 110-SF-Y/1	1	29,88	DPSE 110-SF-Y/20	20	23,98
12,5	300	natur	Feinschliff mit Schutzfolie	DPSE 125-SF/300	34,16	DPSE 125-SF-Y/1	1	29,88	DPSE 125-SF-Y/20	20	23,98

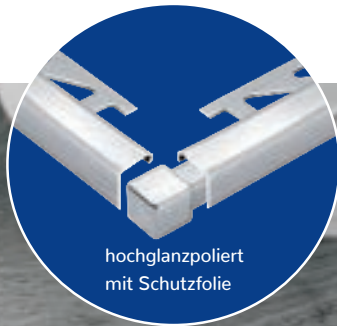

hochglanzpoliert mit Schutzfolie





SQUARELINE PVC

Quadratisches Abschlussprofil für die Wand

Material: PVC

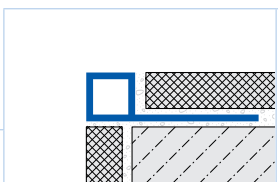

Innen- und Außenecke

Material:
PVC



Innen- und Außenecke

Material:
PVC



VE1	VE2	VE3	Kat. C
10	50	-	

VE1	VE2	VE3
1	-	-

VE1	VE2	VE3
1	-	-

Höhe mm	Länge cm	Farbe	Referenz	€/lfm	Referenz	Stück/Blister	€/Stück	Referenz	Stück/Beutel	€/Stück
7	250	weiß	DPSP 730/250	3,98	DPSP 730-Y/2	2	2,94	DPSP 730-Y/20	20	2,04
9	250	weiß	DPSP 930/250	4,46	DPSP 930-Y/2	2	2,94	DPSP 930-Y/20	20	2,04
11	250	weiß	DPSP 1130/250	4,74	DPSP 1130-Y/2	2	2,94	DPSP 1130-Y/20	20	2,04
7	250	schwarz	DPSP 733/250	3,98	DPSP 733-Y/2	2	2,94	DPSP 733-Y/20	20	2,04
9	250	schwarz	DPSP 933/250	4,46	DPSP 933-Y/2	2	2,94	DPSP 933-Y/20	20	2,04
11	250	schwarz	DPSP 1133/250	4,74	DPSP 1133-Y/2	2	2,94	DPSP 1133-Y/20	20	2,04
7	250	silbergrau	DPSP 751/250	3,98	DPSP 751-Y/2	2	2,94	DPSP 751-Y/20	20	2,04
9	250	silbergrau	DPSP 951/250	4,46	DPSP 951-Y/2	2	2,94	DPSP 951-Y/20	20	2,04
11	250	silbergrau	DPSP 1151/250	4,74	DPSP 1151-Y/2	2	2,94	DPSP 1151-Y/20	20	2,04

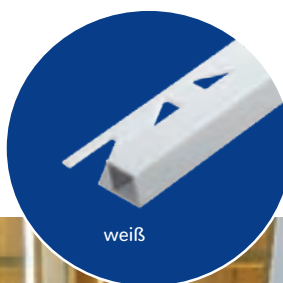
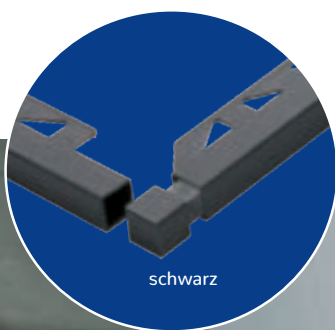



LEBENS RÄUME

DURCHGÄNGIGES PROFILDESIGN MIT SCHWARZ MATT RAL 9011

MIT PROFIL



DURAL
COLOUR
FITTING



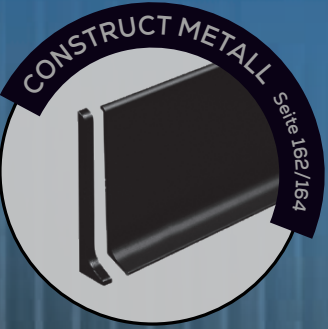
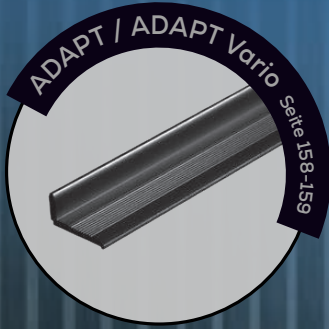
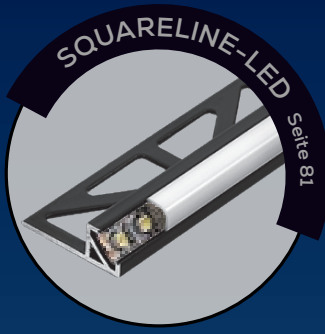
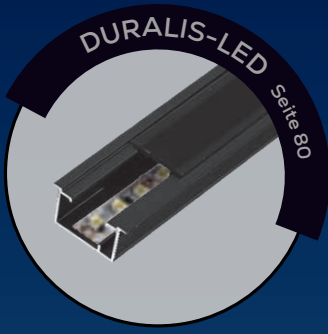

DURAL
COLOUR
FITTING



DUROSOL

Winkel-Abschlussprofil für Wand und Boden mit schmaler Sichtkante
Material: Aluminium pulverbeschichtet

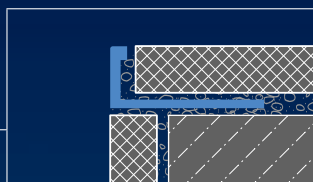

VE1	VE2	VE3	Kat.
10	40	-	A

Höhe mm	Länge cm	Farbe	Referenz	€/lfm
6	250	RAL 0808005 sand	DSAC 680/250	8,16
7	250	RAL 0808005 sand	DSAC 780/250 Neu	8,30
8	250	RAL 0808005 sand	DSAC 880/250	8,46
9	250	RAL 0808005 sand	DSAC 980/250 Neu	8,68
10	250	RAL 0808005 sand	DSAC 1080/250	8,92
11	250	RAL 0808005 sand	DSAC 1180/250	9,26
12,5	250	RAL 0808005 sand	DSAC 1280/250	9,80

6	250	RAL 0006500 betongrau	DSAC 665/250	8,16
7	250	RAL 0006500 betongrau	DSAC 765/250 Neu	8,30
8	250	RAL 0006500 betongrau	DSAC 865/250	8,46
9	250	RAL 0006500 betongrau	DSAC 965/250 Neu	8,68
10	250	RAL 0006500 betongrau	DSAC 1065/250	8,92
11	250	RAL 0006500 betongrau	DSAC 1165/250	9,26
12,5	250	RAL 0006500 betongrau	DSAC 1265/250	9,80

6	250	RAL 9011 schwarz matt	DSACM 611/250	8,16
7	250	RAL 9011 schwarz matt	DSACM 711/250 Neu	8,30
8	250	RAL 9011 schwarz matt	DSACM 811/250	8,46
9	250	RAL 9011 schwarz matt	DSACM 911/250 Neu	8,68
10	250	RAL 9011 schwarz matt	DSACM 1011/250	8,92
11	250	RAL 9011 schwarz matt	DSACM 1111/250	9,26
12,5	250	RAL 9011 schwarz matt	DSACM 1211/250	9,80
22	250	RAL 9011 schwarz matt	DSACM 2211/250 Neu	11,90

6	300	RAL 0808005 sand	DSAC 680/300	8,16
8	300	RAL 0808005 sand	DSAC 880/300	8,46
10	300	RAL 0808005 sand	DSAC 1080/300	8,92
11	300	RAL 0808005 sand	DSAC 1180/300	9,26
12,5	300	RAL 0808005 sand	DSAC 1280/300	9,80

6	300	RAL 0006500 betongrau	DSAC 665/300	8,16
8	300	RAL 0006500 betongrau	DSAC 865/300	8,46
10	300	RAL 0006500 betongrau	DSAC 1065/300	8,92
11	300	RAL 0006500 betongrau	DSAC 1165/300	9,26
12,5	300	RAL 0006500 betongrau	DSAC 1265/300	9,80

6	300	RAL 9011 schwarz matt	DSACM 611/300	8,16
8	300	RAL 9011 schwarz matt	DSACM 811/300	8,46
10	300	RAL 9011 schwarz matt	DSACM 1011/300	8,92
11	300	RAL 9011 schwarz matt	DSACM 1111/300	9,26
12,5	300	RAL 9011 schwarz matt	DSACM 1211/300	9,80

DURAL COLOUR FITTING

DURAPLUS
DIAMOND ab Seite 9
SQUARELINE ab Seite 12
DURONDELL ab Seite 32
myVARIO-LINE ab Seite 119
SHOWER-GK ab Seite 124
TI-SHELF ab Seite 132

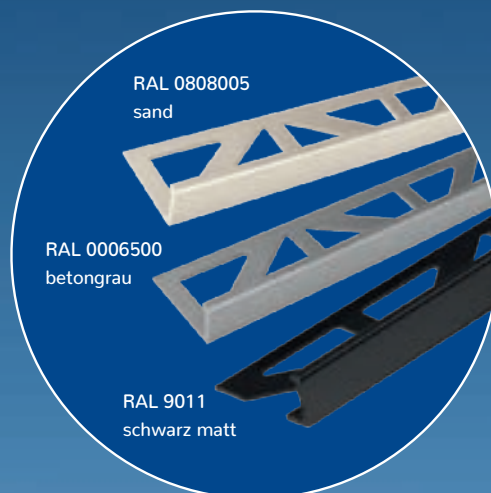

Länge
3 m





DUROSOL SALT'n'PEPPER

Winkel-Abschlussprofil für Wand und Boden mit feiner Strukturbeschichtung
Material: Aluminium pulverbeschichtet

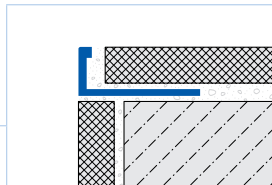

VE1	VE2	VE3	Kat.
10	40	–	A

Höhe mm	Länge cm	Farbe	Referenz	€/lfm
---------	----------	-------	----------	-------

Oberfläche: pulverbeschichtet *

7	250	Salt'n'pepper weiß	DSAC 744/250 *	9,66
9	250	Salt'n'pepper weiß	DSAC 944/250 *	9,84
10	250	Salt'n'pepper weiß	DSAC 1044/250 *	10,20
11	250	Salt'n'pepper weiß	DSAC 1144/250 *	10,48
7	250	Salt'n'pepper schwarzbraun	DSAC 746/250 *	9,66
9	250	Salt'n'pepper schwarzbraun	DSAC 946/250 *	9,84
10	250	Salt'n'pepper schwarzbraun	DSAC 1046/250 *	10,20
11	250	Salt'n'pepper schwarzbraun	DSAC 1146/250 *	10,48
12,5	250	Salt'n'pepper schwarzbraun	DSAC 1246/250 *	10,74
7	250	Salt'n'pepper anthrazit	DSAC 745/250 *	9,66
9	250	Salt'n'pepper anthrazit	DSAC 945/250 *	9,84
11	250	Salt'n'pepper anthrazit	DSAC 1145/250 *	10,48

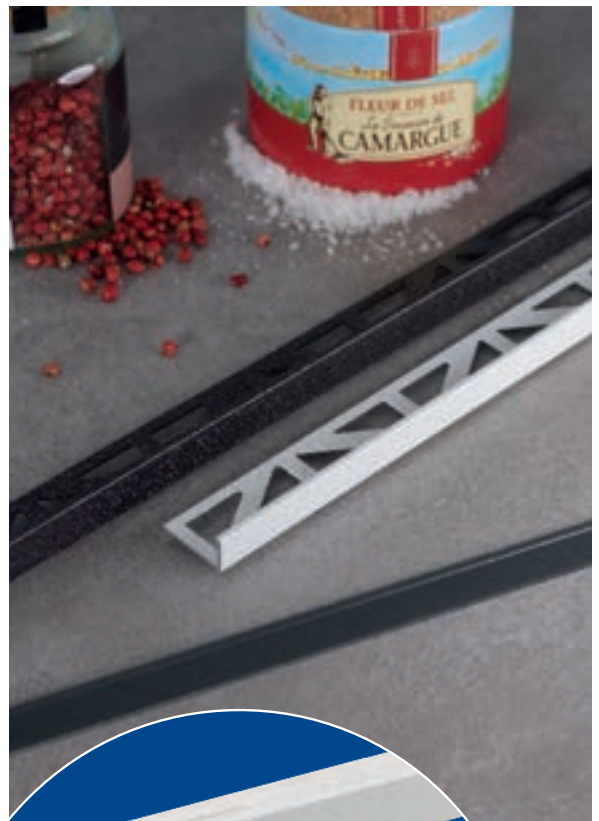

*** Hinweis:**
Lieferung nur noch solange Vorrat reicht

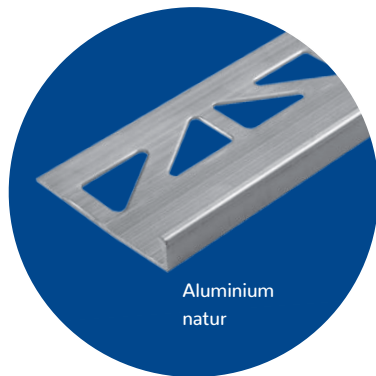

Aluminium natur

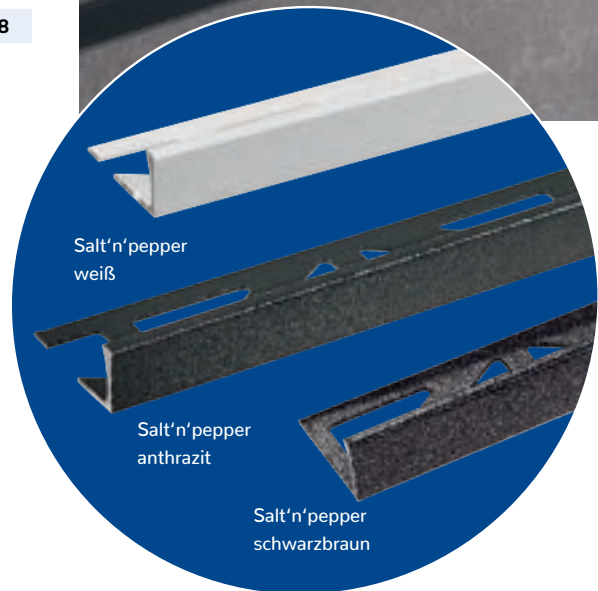

Salt'n'pepper weiß

Salt'n'pepper anthrazit

Salt'n'pepper schwarzbraun

DUROSOL Aluminium

Winkel-Abschlussprofil für Wand und Boden mit schmaler Sichtkante mit extra breitem Auflageschenkel 44 mm
Material: Aluminium

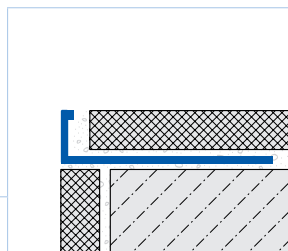

VE1	VE2	VE3	Kat.
10	40	–	A

Höhe mm	Länge cm	Farbe	Referenz	€/lfm
---------	----------	-------	----------	-------

Oberfläche: natur

8	250	natur	DSA 80-L/250	6,32
10	250	natur	DSA 100-L/250	6,40
8	300	natur	DSA 80-L/300	6,32
10	300	natur	DSA 100-L/300	6,40



Auflageschenkel 44 mm



LEBENS RÄU M E

DUROSOL „NEW WHITE“ - SAGEN SIE JA ZUM TRAUM IN WEISS

MIT PROFIL

DUROSOL Aluminium

Winkel-Abschlussprofil für Wand und Boden mit schmaler Sichtkante

Material: Aluminium

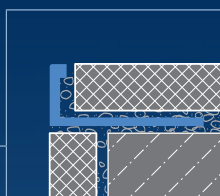

VE1	VE2	VE3	Kat.
10	40	-	A

Höhe mm	Länge cm	Farbe	Referenz	€/lfm
---------	----------	-------	----------	-------

Oberfläche: pulverbeschichtet

6	250	RAL 9003 weiß matt	DSACM 612/250 Neu	8,16
8	250	RAL 9003 weiß matt	DSACM 812/250 Neu	8,46
10	250	RAL 9003 weiß matt	DSACM 1012/250 Neu	8,92
11	250	RAL 9003 weiß matt	DSACM 1112/250 Neu	9,26
12,5	250	RAL 9003 weiß matt	DSACM 1212/250 Neu	9,80

Oberfläche: pulverbeschichtet

6	250	weiß glänzend	DSAC 630/250	8,16
8	250	weiß glänzend	DSAC 830/250	8,46
9	250	weiß glänzend	DSAC 930/250	8,68
10	250	weiß glänzend	DSAC 1030/250	8,92
11	250	weiß glänzend	DSAC 1130/250	9,26
12,5	250	weiß glänzend	DSAC 1230/250	9,80

8	300	weiß glänzend	DSAC 830/300	8,46
10	300	weiß glänzend	DSAC 1030/300	8,92
12,5	300	weiß glänzend	DSAC 1230/300	9,80





DUROSOL Aluminium

Winkel-Abschlussprofil für Wand und Boden mit schmaler Sichtkante

Material: Aluminium

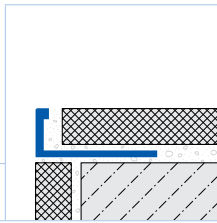

VE1	VE2	VE3	Kat.
10	40	-	A

Höhe mm	Länge cm	Farbe	Referenz	€/ lfm
---------	----------	-------	----------	--------

Oberfläche: pulverbeschichtet

6	250	schwarz glänzend	DSAC 633/250	8,16
8	250	schwarz glänzend	DSAC 833/250	8,46
9	250	schwarz glänzend	DSAC 933/250	8,68
10	250	schwarz glänzend	DSAC 1033/250	8,92
12,5	250	schwarz glänzend	DSAC 1233/250	9,80
8	300	schwarz glänzend	DSAC 833/300	8,46
10	300	schwarz glänzend	DSAC 1033/300	8,92
12,5	300	schwarz glänzend	DSAC 1233/300	9,80

Oberfläche: pulverbeschichtet

22	250	anthrazit Neu	DSAC 2216/250	11,90
22	250	platingrau Neu	DSAC 2236/250	11,90

OUTDOOR

Neue Farben in neuer 22 mm Höhe - ideal für die Verlegung von 20 mm Terrassenplatten



DUROSOL Aluminium

Winkel-Abschlussprofil für Wand und Boden mit schmaler Sichtkante

Material: Aluminium

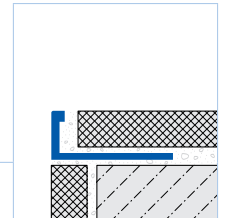

VE1	VE2	VE3	Kat.
10	40	-	A

Höhe mm	Länge cm	Farbe	Referenz	€/ lfm
---------	----------	-------	----------	--------

Oberfläche: natur

6	100	natur	DSA 60/100	5,68
8	100	natur	DSA 80/100	5,80
9	100	natur	DSA 90/100	5,90
10	100	natur	DSA 100/100	6,04
11	100	natur	DSA 110/100	6,46
12,5	100	natur	DSA 125/100	6,74
15	100	natur	DSA 150/100	7,30
2	250	natur	DSA 20/250	4,88
3	250	natur	DSA 30/250	4,98
4,5	250	natur	DSA 45/250	5,12
6	250	natur	DSA 60/250	5,42
8	250	natur	DSA 80/250	5,52
9	250	natur	DSA 90/250	5,58
10	250	natur	DSA 100/250	5,68
11	250	natur	DSA 110/250	5,86
12,5	250	natur	DSA 125/250	6,04
15	250	natur	DSA 150/250	6,82
16,5	250	natur	DSA 165/250	7,42
18,5	250	natur	DSA 185/250	7,94
20	250	natur	DSA 200/250	8,26
22	250	natur	DSA 220/250	8,74
25	250	natur	DSA 250/250	9,20
30	250	natur	DSA 300/250	10,20
8	300	natur	DSA 80/300	5,52
9	300	natur	DSA 90/300	5,58
10	300	natur	DSA 100/300	5,68
11	300	natur	DSA 110/300	5,86
12,5	300	natur	DSA 125/300	6,04
15	300	natur	DSA 150/300	6,82





DUROSOL Aluminium

Winkel-Abschlussprofil für Wand und Boden mit schmaler Sichtkante
Material: Aluminium

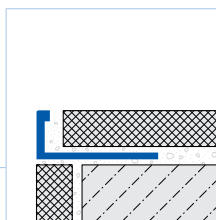

VE1	VE2	VE3	Kat.
10	40	–	A
Höhe mm	Länge cm	Farbe	Referenz

Oberfläche: eloxiert

6	100	silber	DSAE 60/100	7,90
8	100	silber	DSAE 80/100	8,24
9	100	silber	DSAE 90/100	8,44
10	100	silber	DSAE 100/100	8,70
11	100	silber	DSAE 110/100	9,04
12,5	100	silber	DSAE 125/100	9,32
15	100	silber	DSAE 150/100	10,86
2	250	silber	DSAE 20/250	6,88
3	250	silber	DSAE 30/250	6,98
4,5	250	silber	DSAE 45/250	7,18
6	250	silber	DSAE 60/250	7,42
8	250	silber	DSAE 80/250	7,78
9	250	silber	DSAE 90/250	7,90
10	250	silber	DSAE 100/250	8,16
11	250	silber	DSAE 110/250	8,42
12,5	250	silber	DSAE 125/250	8,74
15	250	silber	DSAE 150/250	10,10
22	250	silber	DSAE 220/250	12,54
6	250	gold	DSAE 60-G/250	7,78
8	250	gold	DSAE 80-G/250	8,04
9	250	gold	DSAE 90-G/250	8,24
10	250	gold	DSAE 100-G/250	8,48
12,5	250	gold	DSAE 125-G/250	9,32
15	250	gold	DSAE 150-G/250	10,52
8	250	titan	DSAE 80-T/250	8,04
10	250	titan	DSAE 100-T/250	8,48
12,5	250	titan	DSAE 125-T/250	9,32
8	300	silber	DSAE 80/300	7,78
9	300	silber	DSAE 90/300	7,90
10	300	silber	DSAE 100/300	8,16
11	300	silber	DSAE 110/300	8,44
12,5	300	silber	DSAE 125/300	8,74
15	300	silber	DSAE 150/300	10,10

Länge 3 m



DUROSOL Aluminium

Winkel-Abschlussprofil für Wand und Boden mit schmaler Sichtkante
Material: Aluminium

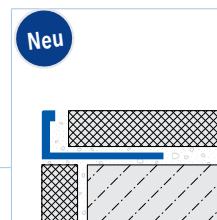

VE1	VE2	VE3	Kat.
10	40	–	A
Höhe mm	Länge cm	Farbe	Referenz

Oberfläche: eloxiert gebürstet

8	250	silber	DSAE 80-SF/250 Neu	9,38
10	250	silber	DSAE 100-SF/250 Neu	9,84
12,5	250	silber	DSAE 125-SF/250 Neu	10,54

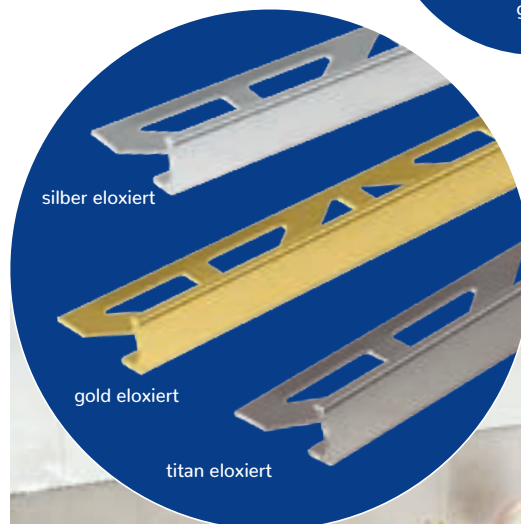



DUROSOL Aluminium

Winkel-Abschlussprofil für
Wand und Boden mit schmaler Sichtkante
Material: Aluminium

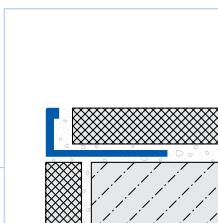

VE1	VE2	VE3	Kat.
10	40	-	AA
Höhe mm	Länge cm	Farbe	Referenz

Oberfläche hochglanzeloxiert

6	250	silber	DSA 662/250	10,22
8	250	silber	DSA 862/250	10,82
10	250	silber	DSA 1062/250	11,32
12,5	250	silber	DSA 1262/250	12,32
8	250	titan	DSA 863/250	11,42
10	250	titan	DSA 1063/250	11,66
12,5	250	titan	DSA 1263/250	12,60

DUROSOL Aluminium

Winkel-Abschlussprofil für
Wand und Boden mit schmaler Sichtkante
Material: Aluminium

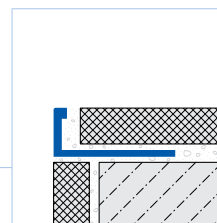

VE1	VE2	VE3	Kat.
10	40	-	AA
Höhe mm	Länge cm	Farbe	Referenz

Oberfläche hochglanzeloxiert gebürstet

8	250	silber	DSA 862-SF/250	13,04
10	250	silber	DSA 1062-SF/250	13,56
12,5	250	silber	DSA 1262-SF/250	14,66
8	250	titan	DSA 863-SF/250	13,40
10	250	titan	DSA 1063-SF/250	13,96
12,5	250	titan	DSA 1263-SF/250	15,12

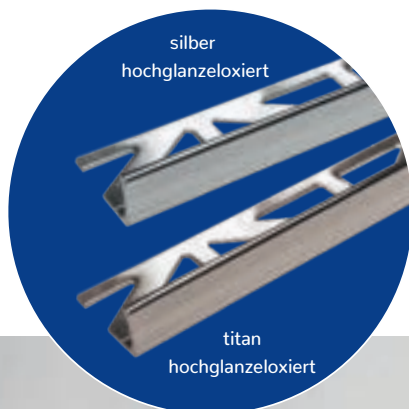



DUROSOL Messing

Winkel-Abschlussprofil für Wand und Boden mit schmaler Sichtkante
Material: Messing natur

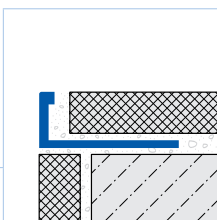

VE1	VE2	VE3	Kat.		
10	40	300	A		
Höhe mm	Länge cm	Farbe	Oberfläche	Referenz	€/lfm

Oberfläche: natur

3	250	Messing	natur	DSM 30/250	14,46
6	250	Messing	natur	DSM 60/250	15,38
8	250	Messing	natur	DSM 80/250	16,34
9	250	Messing	natur	DSM 90/250	16,84
10	250	Messing	natur	DSM 100/250	17,52
11	250	Messing	natur	DSM 110/250	18,04
12,5	250	Messing	natur	DSM 125/250	18,50
15	250	Messing	natur	DSM 150/250	20,90
18,5	250	Messing	natur	DSM 185/250	23,42
20	250	Messing	natur	DSM 200/250	24,26
22	250	Messing	natur	DSM 220/250	25,76
25	250	Messing	natur	DSM 250/250	27,50

DUROSOL Messing

Winkel-Abschlussprofil für Wand und Boden mit schmaler Sichtkante
Material: Messing

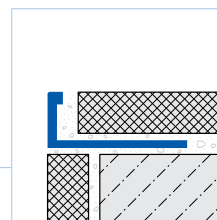

VE1	VE2	VE3	Kat.		
10	40	300	A		
Höhe mm	Länge cm	Farbe	Oberfläche	Referenz	€/lfm

Oberfläche: hochglänzend mit Schutzfolie

6	250	Messing	poliert	DSM 60-SP/250	27,96
8	250	Messing	poliert	DSM 80-SP/250	28,98
10	250	Messing	poliert	DSM 100-SP/250	30,16
12,5	250	Messing	poliert	DSM 125-SP/250	31,12

DUROSOL Messing

Winkel-Abschlussprofil für Wand und Boden mit schmaler Sichtkante
Material: Messing

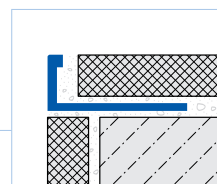

VE1	VE2	VE3	Kat.		
10	40	300	A		
Höhe mm	Länge cm	Farbe	Oberfläche	Referenz	€/lfm

Oberfläche: verchromt

6	250	Messing	verchromt	DSM 60-SC/250	38,28
8	250	Messing	verchromt	DSM 80-SC/250	39,09
9	250	Messing	verchromt	DSM 90-SC/250	39,82
10	250	Messing	verchromt	DSM 100-SC/250	40,20
12,5	250	Messing	verchromt	DSM 125-SC/250	41,20





DUROSOL Edelstahl (V2A/304)

Winkel-Abschlussprofil für Wand und Boden mit schmaler Sichtkante
Material: Edelstahl (V2A/304)

Edelstahl
Rostfrei

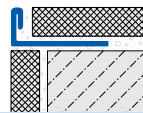

VE1	VE2	VE3			
10	40	300		Kat. A	

Höhe mm	Länge cm	Farbe	Referenz	€/lfm
---------	----------	-------	----------	-------

Oberfläche natur

6	100	natur	DSE 60/100	17,70
8	100	natur	DSE 80/100	18,44
10	100	natur	DSE 100/100	19,36
11	100	natur	DSE 110/100	19,60
12,5	100	natur	DSE 125/100	19,88
2	250	natur	DSE 20/250	15,16
3	250	natur	DSE 30/250	15,16
4,5	250	natur	DSE 45/250	15,84
6	250	natur	DSE 60/250	16,42
7	250	natur	DSE 70/250 Neu	16,50
8	250	natur	DSE 80/250	17,00
9	250	natur	DSE 90/250	17,50
10	250	natur	DSE 100/250	17,94
11	250	natur	DSE 110/250	18,16
12,5	250	natur	DSE 125/250	18,44
14	250	natur	DSE 140/250	18,96
15	250	natur	DSE 150/250	19,60
17	250	natur	DSE 170/250	20,42
20	250	natur	DSE 200/250	21,86
22	250	natur	DSE 220/250	23,38
25	250	natur	DSE 250/250	25,04
30	250	natur	DSE 300/250	26,88
6	300	natur	DSE 60/300	16,42
8	300	natur	DSE 80/300	17,00
9	300	natur	DSE 90/300	17,50
10	300	natur	DSE 100/300	17,94
11	300	natur	DSE 110/300	18,16
12,5	300	natur	DSE 125/300	18,44
15	300	natur	DSE 150/300	19,60

Material: Edelstahl (V4A/316); Oberfläche natur

6	250	natur	DSE 60 V4A/250	19,26
8	250	natur	DSE 80 V4A/250	19,96
10	250	natur	DSE 100 V4A/250	20,94
12,5	250	natur	DSE 125 V4A/250	21,56



DUROSOL Edelstahl (V2A/304)

Winkel-Abschlussprofil für Wand und Boden mit schmaler Sichtkante
Material: Edelstahl (V2A/304)

Edelstahl
Rostfrei

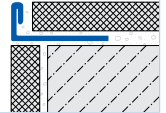

VE1	VE2	VE3			
10	40	300		Kat. A	

Höhe mm	Länge cm	Farbe	Referenz	€/lfm
---------	----------	-------	----------	-------

Oberfläche hochglanzpoliert mit Schutzfolie

3	250	natur	DSE 30-SP/250	22,68
4,5	250	natur	DSE 45-SP/250	23,50
6	250	natur	DSE 60-SP/250	24,62
8	250	natur	DSE 80-SP/250	25,50
9	250	natur	DSE 90-SP/250	25,98
10	250	natur	DSE 100-SP/250	26,48
11	250	natur	DSE 110-SP/250	27,00
12,5	250	natur	DSE 125-SP/250	27,46
15	250	natur	DSE 150-SP/250	29,06
17	250	natur	DSE 170-SP/250	30,48
20	250	natur	DSE 200-SP/250	32,72
22	250	natur	DSE 220-SP/250	35,00
25	250	natur	DSE 250-SP/250	37,38
30	250	natur	DSE 300-SP/250	40,10

VE1	VE2	VE3			
10	40	-		Kat. A	Neue Höhen

Oberfläche Feinschliff mit Schutzfolie

6	250	natur	DSE 60-SF/250 Neu	26,80
7	250	natur	DSE 70-SF/250 Neu	27,62
8	250	natur	DSE 80-SF/250	28,48
10	250	natur	DSE 100-SF/250	30,24
11	250	natur	DSE 110-SF/250	31,06
12,5	250	natur	DSE 125-SF/250	31,72

Länge
3 m

