



Sicherheits-Treppenkantenprofile

Safety stair nosings Nez de marches de sécurité

VE	10x 2,50 m			
F3 Alu poliert	28062503			
F4 Alu silber	28062504			
F9 Alu sand	28062509			
VE 10	48,90 €/St			
< VE	56,24 €/St			
F5 Alu gold	28062505			
F6 Alu bronze	28062506			
F2 Alu edelstahloptik	28062502			
VE 10	53,85 €/St			
< VE	61,93 €/St			
F7 Messing poliert*	28062507			
VE 10	220,15 €/St			
< VE	253,17 €/St			



VE	10x 2,50 m			
F4 Alu silber	28162504			
VE 10	52,75 €/St			
< VE	60,66 €/St			
F2 Alu edelstahloptik	28162502			
VE 10	57,05 €/St			
< VE	65,61 €/St			
F7 Messing poliert*	28162507			
VE 10	225,15 €/St			
< VE	258,92 €/St			

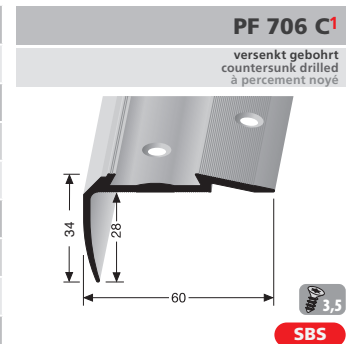

VE	10x 2,50 m			
F3 Alu poliert	28082503			
F4 Alu silber	28082504			
F9 Alu sand	28082509			
VE 10	49,20 €/St			
< VE	56,58 €/St			
F5 Alu gold	28082505			
F6 Alu bronze	28082506			
F2 Alu edelstahloptik	28082502			
VE 10	54,45 €/St			
< VE	62,62 €/St			



¹für auswechselbare PVC-Einlagen (S. 93) for exchangeable PVC-inserts (Page 93) pour inserts en PVC interchangeables (page 93)

* Messing-Preise können sich ändern! Brass prices may change! Les prix du laiton peuvent subir des variations!

** Auslaufartikel! Discontinued product! Article discontinué!

Sicherheits-Treppenkantenprofile

Safety stair nosings Nez de marches de sécurité



PF 700¹

versenkt gebohrt
countersunk drilled
à percement noyé

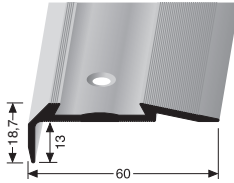

3,5

SBS

VE	10x 2,50 m			
F4 Alu silber	28002504			
VE 10	43,70 €/St			
< VE	50,26 €/St			
F2 Alu edelstahloptik	28002502			
VE 10	47,75 €/St			
< VE	54,91 €/St			

PF 707 A¹

versenkt gebohrt
countersunk drilled
à percement noyé

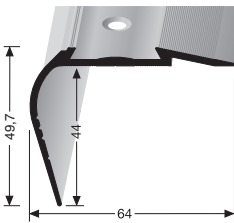

3,5

SBS

VE	10x 2,50 m			
F3 Alu poliert	28072503			
F4 Alu silber	28072504			
F9 Alu sand	28072509			
VE 10	57,80 €/St			
< VE	66,47 €/St			
F5 Alu gold	28072505			
F6 Alu bronze	28072506			
F2 Alu edelstahloptik	28072502			
VE 10	64,15 €/St			
< VE	73,77 €/St			

PF 707 C¹

doppelt versenkt gebohrt
double countersunk drilled
à percement noyé

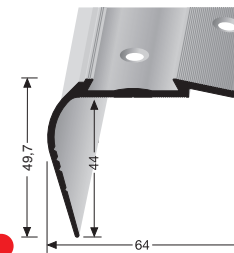

3,5

SBS

VE	10x 2,50 m			
F4 Alu silber	28172504			
VE 10	61,40 €/St			
< VE	70,61 €/St			
F2 Alu edelstahloptik	28172502			
VE 10	67,40 €/St			
< VE	77,51 €/St			



¹für auswechselbare PVC-Einlagen (S. 93) for exchangeable PVC-inserts (Page 93) pour inserts en PVC interchangeables (page 93)



Sicherheits-Treppenkantenprofile

Safety stair nosings Nez de marches de sécurité

VE	1x 25 m Rolle roll roll		
F100 schwarz black noir	25042001		
F130 braun brown brun	25042130		
F140 anthrazit anthracite anthracite	25042140		
F142 hell grau light grey gris clair	25042142		
F143 beige grau beige grey beige gris	25042143		
F149 beige beige beige	25042149		
F169 blau blue bleu	25042169		
F189 rot red rouge	25042189		
F190 gelb yellow jaune	25042190		
VE 1	3,55 €/m		
F200 nachleuchtend photoluminescent fluorescent	25042200		
VE 1	26,60 €/m		

PF 2504
gerillt, Breite 29 mm
grooved, Width 29 mm
rainuré, Largeur 29 mm

rutschhemmende Längsrillen
slip-resistant longitudinal nerves
rainures longitudinales antidérapantes

TOLERANZ TOLERANCE + 0,3 mm

R9

Luftpolster air pads
cavité d'air

VE	1x 25 m Rolle roll roll		
F100 schwarz black noir	25052001		
F130 braun brown brun	25052130		
F140 anthrazit anthracite anthracite	25052140		
F142 hell grau light grey gris clair	25052142		
F143 beige grau beige grey beige gris	25052143		
F149 beige beige beige	25052149		
F169 blau blue bleu	25052169		
F189 rot red rouge	25052189		
F190 gelb yellow jaune	25052190		
VE 1	3,55 €/m		
F200 nachleuchtend photoluminescent fluorescent	25052200		
VE 1	14,70 €/m		

PF 2505
glatt, Breite 29 mm
plain, Width 29 mm
lisse, Largeur 29 mm

TOLERANZ TOLERANCE + 0,3 mm

R9

Dehnungsfuge
expansion joints
joints de dilatation

TOLERANZ TOLERANCE ± 0,2 mm

nachleuchtend im Dunkeln,
Breite 27,5 mm
photoluminescent in the dark,
Width 27,5
fluorescent,
Largeur 27,5

VE	10x 2,50 m		
F3 Alu poliert	28012503		
F4 Alu silber	28012504		
F9 Alu sand	28012509		
VE 10	28,60 €/St		
< VE	32,89 €/St		
F5 Alu gold	28012505		
F6 Alu bronze	28012506		
F2 Alu edelstahloptik	28012502		
VE 10	30,50 €/St		
< VE	35,08 €/St		

PF 701^{1}**
versenkt gebohrt
countersunk drilled
à percement noyé

3,0

SBS

¹für auswechselbare PVC-Einlagen (siehe oben) for exchangeable PVC-inserts (see above) pour inserts en PVC interchangeables (voir ci-dessus)

* Messing-Preise können sich ändern! Brass prices may change! Les prix du laiton peuvent subir des variations!

** Auslaufartikel! Discontinued product! Article discontinué!

Sicherheits-Treppenkantenprofile

Safety stair nosings Nez de marches de sécurité



PF 702¹

versenkt gebohrt
countersunk drilled
à perçement noyé

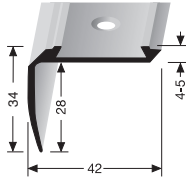

3,0

SBS

VE	10x 2,50 m		
F3 Alu poliert	28022503		
F4 Alu silber	28022504		
F9 Alu sand	28022509		
VE 10	33,65 €/St		
< VE	38,70 €/St		
F5 Alu gold	28022505		
F6 Alu bronze	28022506		
F2 Alu edelstahloptik	28022502		
VE 10	35,05 €/St		
< VE	40,31 €/St		
F7 Messing poliert*/**	28022507		
VE 10	143,55 €/St		
< VE	165,08 €/St		

PF 705¹

versenkt gebohrt
countersunk drilled
à perçement noyé

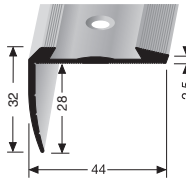

3,0

SBS

VE	10x 2,50 m		
F3 Alu poliert	28052503		
F4 Alu silber	28052504		
F9 Alu sand	28052509		
VE 10	39,45 €/St		
< VE	45,37 €/St		
F5 Alu gold	28052505		
F6 Alu bronze	28052506		
F2 Alu edelstahloptik	28052502		
VE 10	42,80 €/St		
< VE	49,22 €/St		

PF 709¹

versenkt gebohrt
countersunk drilled
à perçement noyé

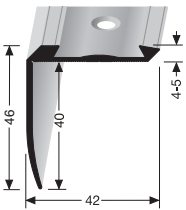

3,0

SBS

VE	10x 2,50 m		
F4 Alu silber	28092504		
F9 Alu sand	28092509		
VE 10	40,05 €/St		
< VE	46,06 €/St		
F5 Alu gold	28092505		
F6 Alu bronze	28092506		
F2 Alu edelstahloptik	28092502		
VE 10	44,20 €/St		
< VE	50,83 €/St		

¹für auswechselbare PVC-Einlagen (S. 93) for exchangeable PVC-inserts (Page 93) pour inserts en PVC interchangeables (page 93)

* Messing-Preise können sich ändern! Brass prices may change! Les prix du laiton peuvent subir des variations!

** Auslaufartikel! Discontinued product! Article discontinué!



Sicherheits-Treppenkantenprofile

Safety stair nosings Nez de marches de sécurité

VE	10x 2,50 m			
F4 Alu silber	28032504			
F9 Alu sand	28032509			
VE 10	36,50 €/St			
< VE	41,98 €/St			
F5 Alu gold	28032505			
F6 Alu bronze	28032506			
F2 Alu edelstahloptik	28032502			
VE 10	38,45 €/St			
< VE	44,22 €/St			

PF 703¹
 versenkt gebohrt
 countersunk drilled
 à percement noyé

Sollbiegestelle
 Predetermined
 bending point
 Point de pliage

3,0
SBS

VE	10x 2,50 m			
F4 Alu silber	28042504			
F9 Alu sand	28042509			
VE10	44,55 €/St			
< VE	51,23 €/St			
F5 Alu gold	28042505			
F6 Alu bronze	28042506			
F2 Alu edelstahloptik	28042502			
VE 10	49,20 €/St			
< VE	56,58 €/St			

PF 704¹
 doppelt versenkt gebohrt
 double countersunk drilled
 à percement noyé

3,0
SBS

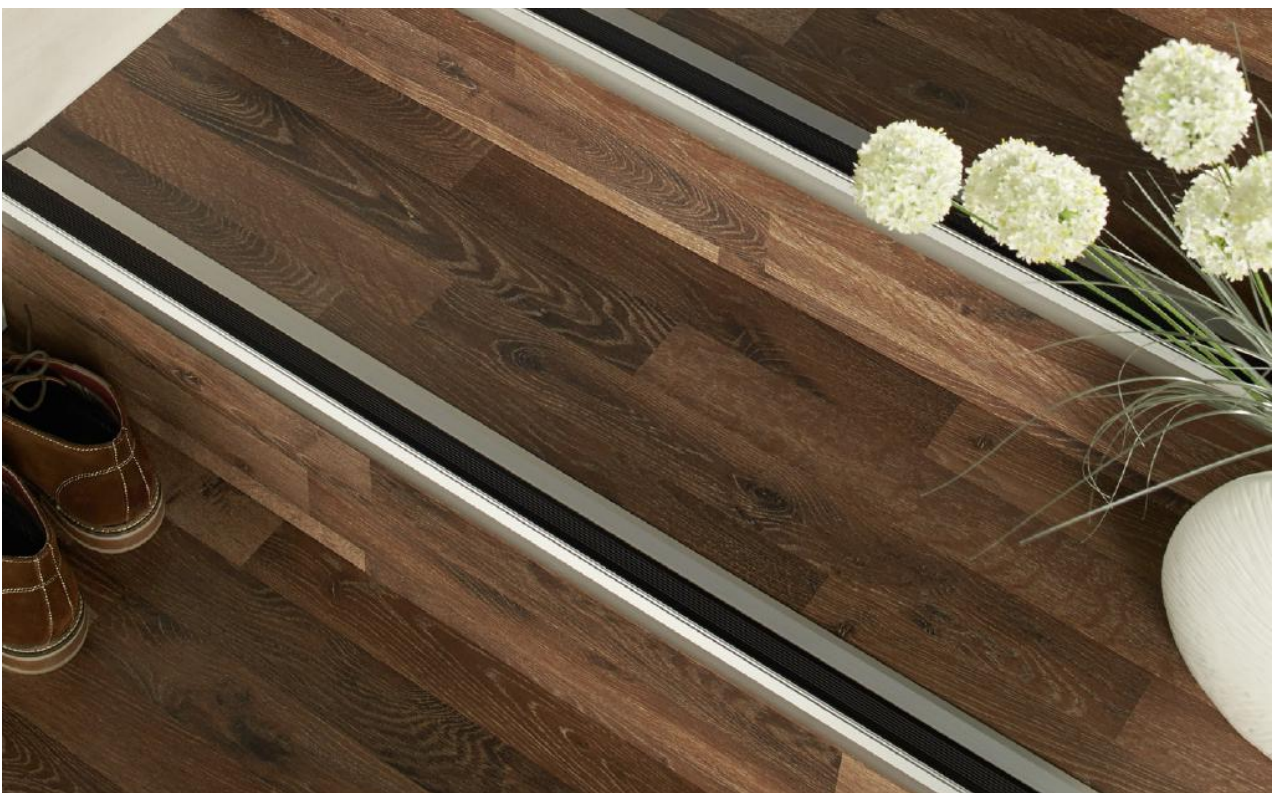

„Reno-TK“ Treppenkantenprofile

“Reno-TK” stair nosings Nez de marches «Reno-TK»



PF 711T

versenkt gebohrt
countersunk drilled
à perçement noyé

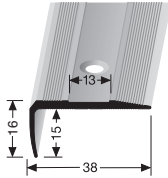

3,0

SBS

ohne Gleitschutzeinlage
without slip-resistant insert
sans insert anti-dérapant

VE	10x 2,50 m	10x 1,00 m		
F3 Alu poliert	28112503	28111003		
F4 Alu silber	28112504	28111004		
F9 Alu sand	28112509	28111009		
VE 10	26,25 €/St	10,80 €/St		
< VE	30,19 €/St	12,42 €/St		
F5 Alu gold	28112505	28111005		
F6 Alu bronze	28112506	28111006		
F2 Alu edelstahloptik	28112502	28111002		
VE 10	29,10 €/St	11,85 €/St		
< VE	33,47 €/St	13,63 €/St		
F7 Messing poliert*	28112507			
VE 10	93,20 €/St			
< VE	107,18 €/St			

Gleitschutz-Einlagen

Slip-resistant-insert Inserts antidérapants

für for pour PF 711

selbstklebend
self-adhesive
auto-adhésif

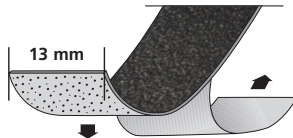

Mineral-Gleitschutzeinlage mit
höchstmöglich rutschhemmender
Wirkung/mit grobkörniger
Oberfläche/Rutschfaktor
R 13 (DIN 51130)

R13

Mineral slip-resistant insert with
maximum non-skid effect/with
coarse-grained surface/slide
factor R 13 (DIN 51130)

Insert **minéral** antidérapant avec gra-
nulation maximale anti-dérapante/
avec surface à gros grains/facteur
antidérapant R 13 (Norme DIN 51130)

VE				1x 25,00 m
PF 2510/13 ohne Körnung without granulation sans granulation				
GE1 schwarz			TOLERANZ TOLERANCE ± 0,2 mm	25102139
GE3 braun				25102141
GE5 beige				25102135
VE 1				1,35 €/m
PF 2511/13 mit Körnung with granulation avec granulation				
GM7 schwarz			TOLERANZ TOLERANCE ± 0/-1 mm	25102138
GM8 gelb				25102137
GM9 braun				25102136
VE 1				2,60 €/m
PF 2512/13 mit PVC with PVC avec PVC				
GS1 schwarz			TOLERANZ TOLERANCE ± 0,2 mm	25102129
GS2 silber				25102124
GS3 braun				25102121
GS4 messing				25102122
GS5 beige				25102125
GS6 grau				25102126
VE 1				2,60 €/m
PF 2513/13 mit PVC with PVC avec PVC				
GR20 nachleuchtend	R10		TOLERANZ TOLERANCE ± 0,2 mm	25131300
VE 1				

T Für Teppichboden nicht geeignet! Not suitable for carpet flooring! Ne pas utiliser pour la moquette!

* Messing-Preise können sich ändern! Brass prices may change! Les prix du laiton peuvent subir des variations!



„Reno-TK“ Treppenkantenprofile

“Reno-TK” stair nosings Nez de marches «Reno-TK»

VE	10x 2,50 m		
F3 Alu poliert	28122503		
F4 Alu silber	28122504		
F9 Alu sand	28122509		
VE 10	39,90 €/St		
< VE	45,89 €/St		
F5 Alu gold	28122505		
F6 Alu bronze	28122506		
F2 Alu edelstahloptik	28122502		
VE 10	41,55 €/St		
< VE	47,78 €/St		
F7 Messing poliert*	28122507		
VE 10	168,45 €/St		
< VE	193,72 €/St		

PF 712T
versenkt gebohrt
countersunk drilled
à percement noyé

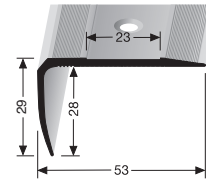

3,0

SBS

ohne Gleitschutzeinlage
without slip-resistant insert
sans insert anti dérapant

Gleitschutz-Einlagen

Slip-resistant-insert Inserts antidérapants

VE	1x 25,00 m		
PF 2510/23 ohne Körnung without granulation sans granulation			
GE1 schwarz			25102239
GE3 braun		TOLERANZ TOLERANCE ± 0,2 mm	25102241
GE5 beige			25102235
VE 1			2,50 €/m
PF 2511/23 mit Körnung with granulation avec granulation			
GM7 schwarz			25102238
GM8 gelb		TOLERANZ TOLERANCE + 0/-1 mm	25102237
GM9 braun			25102236
GM10 schwarz-gelb			25102210
VE 1			3,80 €/m
PF 2512/23 mit PVC with PVC avec PVC			
GS1 schwarz			25102229
GS2 silber		TOLERANZ TOLERANCE ± 0,2 mm	25102224
GS3 braun			25102221
GS4 messing			25102222
GS5 beige			25102225
GS6 grau			25102226
VE 1			3,80 €/m

für for pour **PF 712**
selbstklebend
self-adhesive
auto-adhésif

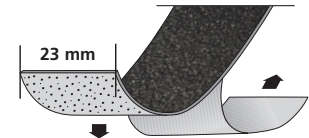

R13

Mineral-Gleitschutzeinlage mit höchstmöglich rutschhemmender Wirkung / mit grobkörniger Oberfläche / Rutschfaktor R 13 (DIN 51130)

Mineral slip-resistant insert with maximum non-skid effect / with coarse-grained surface / slide factor R 13 (DIN 51130)

Insert **minéral** antidérapant avec granulation maximale anti-dérapante / avec surface à gros grains / facteur antidérapant R 13 (Norme DIN 51130)

VE	1x 18,30 m		
PF 2513/23 mit PVC with PVC avec PVC			
GR20 nachleuchtend	R10	TOLERANZ TOLERANCE ± 0,2 mm	25132300
VE 1			20,10 €/m

† Für Teppichboden nicht geeignet! Not suitable for carpet flooring! Ne pas utiliser pour la moquette!

* Messing-Preise können sich ändern! Brass prices may change! Les prix du laiton peuvent subir des variations!

„Reno-TK“ Treppenkantenprofile

“Reno-TK” stair nosings Nez de marches «Reno-TK»



PF 713^T

versenkt gebohrt
countersunk drilled
à percement noyé

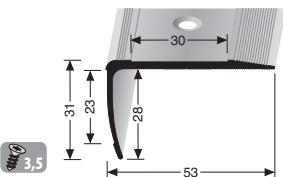

SBS

VE	10x 3,00 m			
F4 Alu silber	28133004			
VE 10	47,80 €/St			
< VE	54,97 €/St			
F2 Alu edelstahloptik	28133002			
VE 10	50,05 €/St			
< VE	57,56 €/St			

ohne Gleitschutzeinlagen without slip-resistant inserts sans inserts anti dérapant

für for pour PF 713

selbstklebend
self-adhesive
auto-adhésif

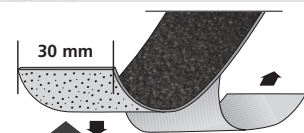

VE			1x 18,30 m
PF 2511/30 mit Körnung with granulation avec granulation			
GM10 mineral schwarz		TOLERANZ TOLERANCE ± 0,2 mm	25113038
GM7 mineral schwarz-gelb			25113010
VE 1			3,80 €/m

Mineral-Gleitschutzeinlage mit höchstmöglich rutschhemmender Wirkung/mit grobkörniger Oberfläche/Rutschfaktor R 13 (DIN 51130)
Mineral slip-resistant insert with maximum non-skid effect/with coarse-grained surface/slide factor R 13 (DIN 51130)
Insert minéral antidérapant avec granulation maximale anti-dérapante/avec surface à gros grains/facteur antidérapant R 13 (Norme DIN 51130)

R13

Gleitschutzeinlage PF 2511/23
siehe Seite 97
slip-resistant insert PF 2511/23
see page 97
insert antidérapant PF 2511/23
voir page 97



PF 713

PF 715^T

doppelt versenkt gebohrt
double countersunk drilled
à percement noyé

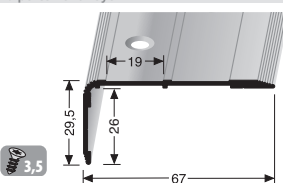

SBS

VE	10x 3,00 m			
F4 Alu silber	28153004			
VE 10	69,40 €/St			
< VE	79,81 €/St			
F2 Alu edelstahloptik	28153002			
VE 10	72,40 €/St			
< VE	83,26 €/St			

ohne Gleitschutzeinlage without slip-resistant insert sans insert anti dérapant

für for pour PF 715

selbstklebend
self-adhesive
auto-adhésif

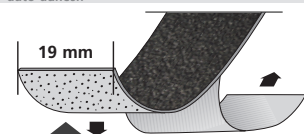

VE			1x 18,30 m
PF 2511/19 mit Körnung with granulation avec granulation			
GM7 mineral schwarz-gelb		TOLERANZ TOLERANCE ± 0,2 mm	25102219
VE 1			3,80 €/m

Mineral-Gleitschutzeinlage mit höchstmöglich rutschhemmender Wirkung/mit grobkörniger Oberfläche/Rutschfaktor R 13 (DIN 51130)
Mineral slip-resistant insert with maximum non-skid effect/with coarse-grained surface/slide factor R 13 (DIN 51130)
Insert minéral antidérapant avec granulation maximale anti-dérapante/avec surface à gros grains/facteur antidérapant R 13 (Norme DIN 51130)

R13

TFür Teppichboden nicht geeignet! Not suitable for carpet flooring! Ne pas utiliser pour la moquette!

Treppenkantenprofile

Stair nosings Nez de marches

VE	10x 2,50 m	15x 1,00 m		
F3 Alu poliert	24032513	24031013		
F4 Alu silber	24032514	24031014		
F9 Alu sand	24032519	24031019		
VE 10/15	19,65 €/St	8,20 €/St		
< VE	22,60 €/St	9,43 €/St		
F5 Alu gold	24032515	24031015		
F6 Alu bronze	24032516	24031016		
F2 Alu edelstahloptik	24032512	24031012		
VE 10/15	21,25 €/St	8,85 €/St		
< VE	24,44 €/St	10,18 €/St		



VE	10x 2,50 m			
F4 Alu silber	25152504			
VE 10	29,80 €/St			
< VE	34,27 €/St			
F2 Alu edelstahloptik	25152502			
VE 10	31,15 €/St			
< VE	35,82 €/St			

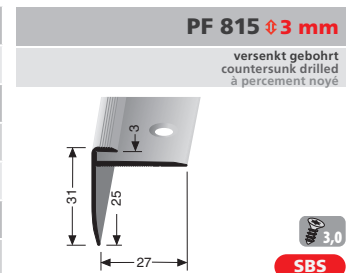

VE	10x 2,50 m	15x 1,00 m		
F3 Alu poliert	24052513	24051013		
F4 Alu silber	24052514	24051014		
F9 Alu sand	24052519	24051019		
VE 10/15	20,75 €/St	8,65 €/St		
< VE	23,86 €/St	9,95 €/St		
F5 Alu gold	24052515	24051015		
F6 Alu bronze	24052516	24051016		
F2 Alu edelstahloptik	24052512	24051012		
VE 10/15	23,30 €/St	9,70 €/St		
< VE	26,80 €/St	11,16 €/St		



VE	10x 2,50 m			
F4 Alu silber	25162504			
VE 10	31,25 €/St			
< VE	35,94 €/St			
F2 Alu edelstahloptik	25162502			
VE 10	33,15 €/St			
< VE	38,12 €/St			

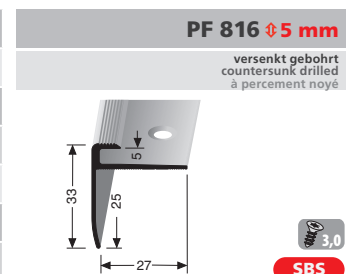

Treppenkantenprofile

Stair nosings Nez de marches

PF 808 $\varnothing 7$ mm

versenkt gebohrt
countersunk drilled
à percement noyé

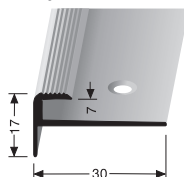

3,0

SBS

VE	10x 2,50 m	15x 1,00 m		
F3 Alu poliert	24072513	24071013		
F4 Alu silber	24072514	24071014		
F9 Alu sand	24072519	24071019		
VE 10/15	21,60 €/St	9,20 €/St		
< VE	24,84 €/St	10,58 €/St		
F5 Alu gold	24072515	24071015		
F6 Alu bronze	24072516	24071016		
F2 Alu edelstahloptik	24072512	24071012		
VE 10/15	24,15 €/St	9,95 €/St		
< VE	27,77 €/St	11,44 €/St		

PF 810 $\varnothing 8,5$ mm

versenkt gebohrt
countersunk drilled
à percement noyé

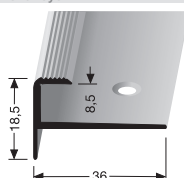

3,0

SBS

VE	10x 2,50 m	15x 1,00 m		
F3 Alu poliert	24082513	24081013		
F4 Alu silber	24082514	24081014		
F9 Alu sand	24082519	24081019		
VE 10/15	21,90 €/St	9,15 €/St		
< VE	25,19 €/St	10,52 €/St		
F5 Alu gold	24082515	24081015		
F6 Alu bronze	24082516	24081016		
F2 Alu edelstahloptik	24082512	24081012		
VE 10/15	24,15 €/St	9,85 €/St		
< VE	27,77 €/St	11,33 €/St		

PF 811 $\varnothing 10,5$ mm

versenkt gebohrt
countersunk drilled
à percement noyé

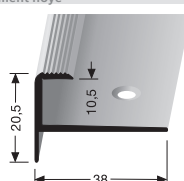

3,0

SBS

VE	10x 2,50 m	15x 1,00 m		
F3 Alu poliert	24102513	24101013		
F4 Alu silber	24102514	24101014		
F9 Alu sand	24102519	24101019		
VE 10/15	24,15 €/St	9,85 €/St		
< VE	27,77 €/St	11,33 €/St		
F5 Alu gold	24102515	24101015		
F6 Alu bronze	24102516	24101016		
F2 Alu edelstahloptik	24102512	24101012		
VE 10/15	26,10 €/St	10,70 €/St		
< VE	30,02 €/St	12,31 €/St		

PF 812 $\varnothing 13,5$ mm

versenkt gebohrt
countersunk drilled
à percement noyé

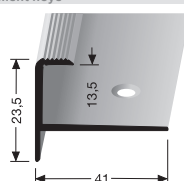

3,0

SBS

VE	10x 2,50 m	15x 1,00 m		
F4 Alu silber	24132514	24131014		
VE 10/15	25,85 €/St	10,60 €/St		
< VE	29,73 €/St	12,19 €/St		
F6 Alu bronze	24132516	24131016		
F2 Alu edelstahloptik	24132512	24131012		
VE 10/15	27,60 €/St	11,35 €/St		
< VE	31,74 €/St	13,05 €/St		

Treppenkantenprofile

Stair nosings Nez de marches

VE	10x 2,50 m	15x 1,00 m		
F4 Alu silber	24152514	24151014		
VE 10/15	26,55 €/St	10,95 €/St		
< VE	30,53 €/St	12,59 €/St		
F6 Alu bronze	24152516	24151016		
F2 Alu edelstahloptik	24152512	24151012		
VE 10/15	29,10 €/St	11,85 €/St		
< VE	33,47 €/St	13,63 €/St		



VE	10x 2,50 m			
F3 Alu poliert	24302503			
F4 Alu silber	24302504			
F9 Alu sand	24302509			
VE 10	27,30 €/St			
< VE	31,40 €/St			
F5 Alu gold	24302505			
F6 Alu bronze	24302506			
F2 Alu edelstahloptik	24302502			
VE 10	31,60 €/St			
< VE	36,34 €/St			

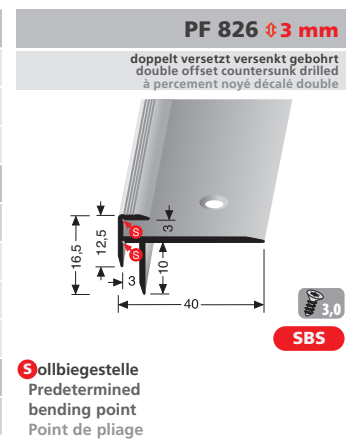

VE	10x 2,50 m			
F3 Alu poliert	24402503			
F4 Alu silber	24402504			
F9 Alu sand	24402509			
VE 10	28,95 €/St			
< VE	33,29 €/St			
F5 Alu gold	24402505			
F6 Alu bronze	24402506			
F2 Alu edelstahloptik	24402502			
VE 10	32,90 €/St			
< VE	37,84 €/St			



VE	10x 2,50 m			
F3 Alu poliert	24552503			
F4 Alu silber	24552504			
F9 Alu sand	24552509			
VE 10	29,30 €/St			
< VE	33,70 €/St			
F5 Alu gold	24552505			
F6 Alu bronze	24552506			
F2 Alu edelstahloptik	24552502			
VE 10	33,20 €/St			
< VE	38,18 €/St			

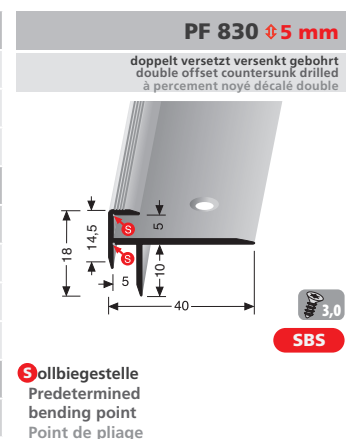

Treppenkantenprofile

Stair nosings Nez de marches

PF 209 $\varnothing 8,7$ mm

doppelt versetzt versenkt gebohrt
double offset countersunk drilled
à percement noyé décalé double

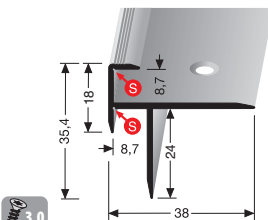

3,0

SBS

Sollbiegestelle
Predetermined
bending point
Point de pliage

VE	6x 3,00 m	6x 2,70 m	10x 1,00 m
F3 Alu poliert	24083023	24082723	24081023
F4 Alu silber	24083024	24082724	24081024
F9 Alu sand	24083029	24082729	24081029
VE 6/10	41,35 €/St	37,10 €/St	14,10 €/St
< VE	47,55 €/St	42,67 €/St	16,22 €/St
F5 Alu gold	24083025	24082725	24081025
F6 Alu bronze	24083026	24082726	24081026
F2 Alu edelstahloptik	24083022	24082722	24081022
VE 6/10	45,95 €/St	41,10 €/St	15,60 €/St
< VE	52,84 €/St	47,27 €/St	17,94 €/St

PF 208 $\varnothing 10,5$ mm

doppelt versetzt versenkt gebohrt
double offset countersunk drilled
à percement noyé décalé double

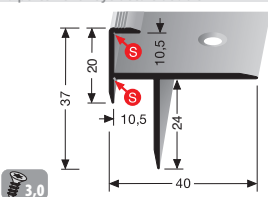

3,0

SBS

Sollbiegestelle Predetermined
bending point Point de pliage

VE	6x 3,00 m	10x 1,00 m
F4 Alu silber	24103024	24101024
VE 6/10	42,60 €/St	14,55 €/St
< VE	48,99 €/St	16,73 €/St
F6 Alu bronze	24103026	24101026
F2 Alu edelstahloptik	24103022	24101022
VE 6/10	47,60 €/St	16,15 €/St
< VE	54,74 €/St	18,57 €/St

PF 207 $\varnothing 13,5$ mm

doppelt versetzt versenkt gebohrt
double offset countersunk drilled
à percement noyé décalé double

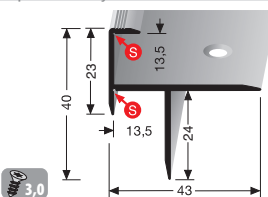

3,0

SBS

Sollbiegestelle Predetermined
bending point Point de pliage

VE	6x 3,00 m	10x 1,00 m
F4 Alu silber	24133024	24131024
VE 6/10	45,00 €/St	15,40 €/St
< VE	51,75 €/St	17,71 €/St
F6 Alu bronze	24133026	24131026
F2 Alu edelstahloptik	24133022	24131022
VE 6/10	49,30 €/St	16,75 €/St
< VE	56,70 €/St	19,26 €/St

PF 206 $\varnothing 15,5$ mm

doppelt versetzt versenkt gebohrt
double offset countersunk drilled
à percement noyé décalé double

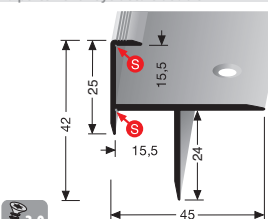

3,0

SBS

Sollbiegestelle
Predetermined
bending point
Point de pliage

VE	6x 3,00 m	10x 1,00 m
F3 Alu poliert	24153023	24151023
F4 Alu silber	24153024	24151024
F9 Alu sand	24153029	24151029
VE 6/10	46,35 €/St	15,95 €/St
< VE	53,30 €/St	18,34 €/St
F5 Alu gold	24153025	24151025
F6 Alu bronze	24153026	24151026
F2 Alu edelstahloptik	24153022	24151022
VE 6/10	50,85 €/St	17,25 €/St
< VE	58,48 €/St	19,84 €/St

Treppenkantenprofile

Stair nosings Nez de marches

VE	6 x 2,50 m			
F3 Alu poliert	24202503			
F4 Alu silber	24202504			
F9 Alu sand	24202509			
VE 6	36,10 €/St			
< VE	41,52 €/St			
F5 Alu gold	24202505			
F6 Alu bronze	24202506			
F2 Alu edelstahloptik	24202502			
VE 6	40,95 €/St			
< VE	47,09 €/St			

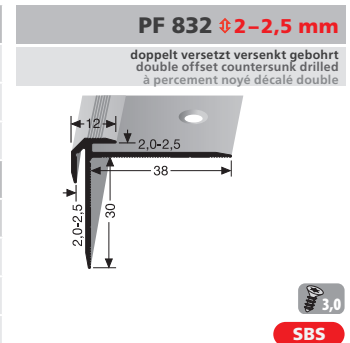

VE	6 x 2,50 m			
F3 Alu poliert	24502503			
F4 Alu silber	24502504			
F9 Alu sand	24502509			
VE 6	38,25 €/St			
< VE	43,99 €/St			
F5 Alu gold	24502505			
F6 Alu bronze	24502506			
F2 Alu edelstahloptik	24502502			
VE 6	42,95 €/St			
< VE	49,39 €/St			



VE	6 x 2,50 m			
F3 Alu poliert	24802503			
F4 Alu silber	24802504			
F9 Alu sand	24802509			
VE 6	40,30 €/St			
< VE	46,35 €/St			
F5 Alu gold	24802505			
F6 Alu bronze	24802506			
F2 Alu edelstahloptik	24802502			
VE 6	45,45 €/St			
< VE	52,27 €/St			



Treppenkantenprofile

Stair nosings Nez de marches

PF 845² ± 3 mm

versenkt gebohrt
countersunk drilled
à perçement noyé

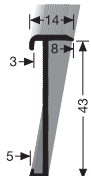

3,5

SBS

VE	10x 3,00 m			
F4 Alu silber	25453004			
VE 10	42,90 €/St			
< VE	49,34 €/St			
F2 Alu edelstahloptik	25453002			
VE 10	45,95 €/St			
< VE	52,84 €/St			
F16 Alu pulver. schwarz	25453016			
VE 10	51,25 €/St			
< VE	58,94 €/St			

PF 845 AE

Außenecke
external corner
angle extérieur



SBS

VE	1x			
F4 Alu silber	25458004			
VE 1	24,50 €/St			
F2 Alu edelstahloptik	25458002			
VE 1	27,20 €/St			
F16 Alu pulver. schwarz	25458016			
VE 1	29,95 €/St			

PF 845 EL

Endstück, links
end cap, left
embout, gauche



SBS

VE	1x			
F4 Alu silber	25456004			
VE 1	20,10 €/St			
F2 Alu edelstahloptik	25456002			
VE 1	22,75 €/St			
F16 Alu pulver. schwarz	25456016			
VE 1	25,10 €/St			

PF 845 ER

Endstück, rechts
end cap, right
embout, droit



SBS

VE	1x			
F4 Alu silber	25457004			
VE 1	20,10 €/St			
F2 Alu edelstahloptik	25457002			
VE 1	22,75 €/St			
F16 Alu pulver. schwarz	25457016			
VE 1	25,10 €/St			

PF 845 / 846



Montagevideo
installation video
vidéo d'installation

2runde Ecken (S. 116–120) round corners (p. 116–120) coins arrondis (p. 116–120)

Treppenkantenprofile

Stair nosings Nez de marches

VE	10x 3,00 m			
F4 Alu silber	25463004			
VE 10	44,45 €/St			
< VE	51,12 €/St			
F2 Alu edelstahloptik	25463002			
VE 10	47,45 €/St			
< VE	54,57 €/St			
F16 Alu pulver. schwarz	25463016			
VE 10	52,75 €/St			
< VE	60,66 €/St			



VE	10x 3,00 m			
F4 Alu silber	25443004			
VE 10	40,30 €/St			
< VE	46,35 €/St			
F2 Alu edelstahloptik	25443002			
VE 10	43,30 €/St			
< VE	49,80 €/St			

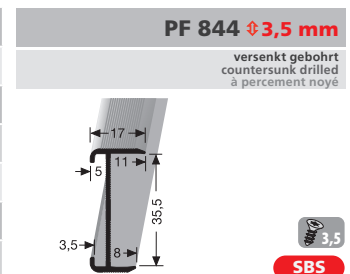

VE	10x 3,00 m			
F4 Alu silber	25473004			
VE 10	90,90 €/St			
< VE	104,54 €/St			
F2 Alu edelstahloptik	25473002			
VE 10	93,80 €/St			
< VE	107,87 €/St			
F16 Alu pulver. schwarz	25473016			
VE 10	110,45 €/St			
< VE	127,02 €/St			

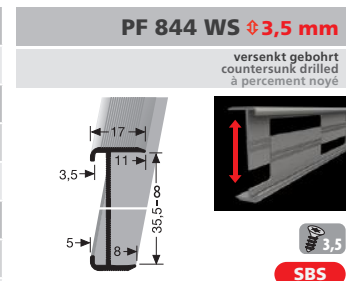

wasserstrahlgeschnitten,
höhenverstellbar ab 35,5 mm
water jet cutting,
height adjustable from 35,5 mm
coupe au jet d'eau, réglable en
hauteur à partir de 35,5 mm

²runde Ecken (S. 116–120) round corners (p. 116–120)
coins arrondis (p. 116–120)



Treppenkantenprofile

Stair nosings Nez de marches



Treppenkantenprofile

Stair nosings Nez de marches

VE	10 x 3,00 m			
F4 Alu silber	28473004			
VE 10	47,20 €/St			
< VE	54,28 €/St			
F2 Alu edelstahloptik	28473002			
VE 10	50,20 €/St			
< VE	57,73 €/St			
F16 Alu pulver. schwarz	28473016			
VE 10	57,05 €/St			
< VE	65,61 €/St			



PF 847 \uparrow 9,8 mm

versenkt gebohrt
countersunk drilled
à percement noyé

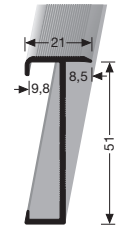

SBS

VE	1x			
F4 Alu silber	28478004			
VE 1	26,00 €/St			
F2 Alu edelstahloptik	28478002			
VE 1	28,85 €/St			
F16 Alu pulver. schwarz	28478016			
VE 1	31,60 €/St			

PF 847 AE

Außenecke
external corner
angle extérieur



SBS

VE	1x			
F4 Alu silber	28476004			
VE 1	21,05 €/St			
F2 Alu edelstahloptik	28476002			
VE 1	23,50 €/St			
F16 Alu pulver. schwarz	28476016			
VE 1	25,95 €/St			

PF 847 EL

Endstück links
end cap left
embout gauche



SBS

VE	1x			
F4 Alu silber	28477004			
VE 1	21,05 €/St			
F2 Alu edelstahloptik	28477002			
VE 1	23,50 €/St			
F16 Alu pulver. schwarz	28477016			
VE 1	25,95 €/St			

PF 847 ER

Endstück rechts
end cap right
embout droit



SBS



Montagevideo
installation video
vidéo d'installation

Treppenkantenprofile

Stair nosings Nez de marches

PF 855 $\diamond 5$ mm

versenkt gebohrt
countersunk drilled
à perçement noyé

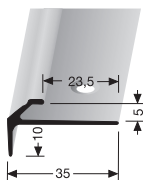

3,0

SBS

VE	10x 2,50 m		
F3 Alu poliert	25552503		
F4 Alu silber	25552504		
F9 Alu sand	25552509		
VE 10	24,45 €/St		
< VE	28,12 €/St		
F5 Alu gold	25552505		
F6 Alu bronze	25552506		
F2 Alu edelstahloptik	25552502		
VE 10	26,45 €/St		
< VE	30,42 €/St		
F7 Messing poliert*	25552507		
VE 10	100,20 €/St		
< VE	115,23 €/St		

PF 850 $\diamond 5$ mm

versenkt gebohrt
countersunk drilled
à perçement noyé

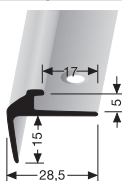

3,0

SBS

VE	10x 2,50 m		
F3 Alu poliert	25502503		
F4 Alu silber	25502504		
F9 Alu sand	25502509		
VE 10	26,25 €/St		
< VE	30,19 €/St		
F5 Alu gold	25502505		
F6 Alu bronze	25502506		
F2 Alu edelstahloptik	25502502		
VE 10	28,80 €/St		
< VE	33,12 €/St		
F7 Messing poliert*	25502507		
VE 10	112,65 €/St		
< VE	129,55 €/St		

PF 852 $\diamond 5$ mm

versenkt gebohrt
countersunk drilled
à perçement noyé

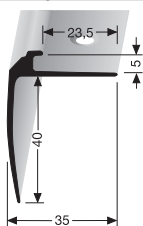

3,0

SBS

VE	10x 2,50 m		
F3 Alu poliert	25522503		
F4 Alu silber	25522504		
F9 Alu sand	25522509		
VE 10	35,15 €/St		
< VE	40,42 €/St		
F5 Alu gold	25522505		
F6 Alu bronze	25522506		
F2 Alu edelstahloptik	25522502		
VE 10	37,25 €/St		
< VE	42,84 €/St		

* Messing-Preise können sich ändern! Brass prices may change! Les prix du laiton peuvent subir des variations!

Treppenkantenprofile

Stair nosings Nez de marches

VE	10x 2,50 m			
F3 Alu poliert	25572503			
F4 Alu silber	25572504			
F9 Alu sand	25572509			
VE 10	30,15 €/St			
< VE	34,67 €/St			
F5 Alu gold	25572505			
F6 Alu bronze	25572506			
F2 Alu edelstahloptik	25572502			
VE 10	33,75 €/St			
< VE	38,81 €/St			



VE	10x 2,50 m	10x 1,00 m		
F3 Alu poliert	25592503			
F4 Alu silber	25592504	25591004		
F9 Alu sand	25592509			
VE 10	25,70 €/St	10,70 €/St		
< VE	29,56 €/St	12,31 €/St		
F5 Alu gold	25592505			
F6 Alu bronze	25592506			
F2 Alu edelstahloptik	25592502	25591002		
VE 10	28,80 €/St	11,85 €/St		
< VE	33,12 €/St	13,63 €/St		

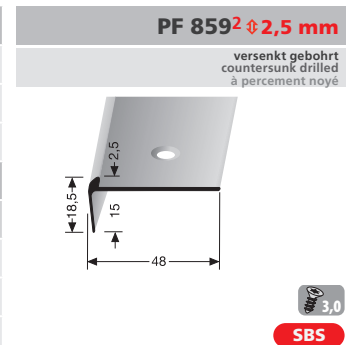

VE	10x 2,50 m			
F4 Alu silber	25532504			
VE 10	30,70 €/St			
< VE	35,31 €/St			
F2 Alu edelstahloptik	25532502			
VE 10	32,10 €/St			
< VE	36,92 €/St			

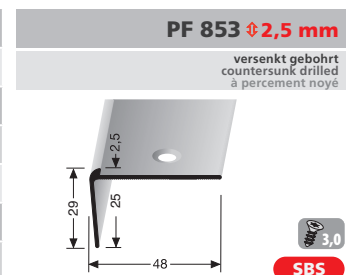

runde Ecken auf Anfrage verfügbar rounded corners available upon request bords arrondis disponible sur demande

²runde Ecken (S. 116–120) round corners (p. 116–120) coins arrondis (p. 116–120)

Treppenkantenprofile

Stair nosings Nez de marches

PF 860² ⌀3 mm

versenkt gebohrt
countersunk drilled
à percement noyé

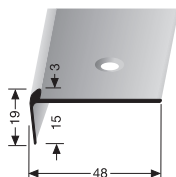

3,0

SBS

VE	10x 2,50 m	10x 1,00 m		
F3 Alu poliert	25602503			
F4 Alu silber	25602504	25601004		
F9 Alu sand	25602509			
VE 10	26,10 €/St	10,90 €/St		
< VE	30,02 €/St	12,54 €/St		
F5 Alu gold	25602505			
F6 Alu bronze	25602506			
F2 Alu edelstahloptik	25602502	25601002		
VE 10	28,95 €/St	12,00 €/St		
< VE	33,29 €/St	13,80 €/St		
F7 Messing poliert*	25602507			
VE 10	103,35 €/St			
< VE	118,85 €/St			

PF 854 ⌀3 mm

versenkt gebohrt
countersunk drilled
à percement noyé

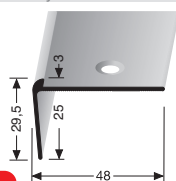

3,0

SBS

VE	10x 2,50 m			
F4 Alu silber	25542504			
VE 10	31,25 €/St			
< VE	35,94 €/St			
F2 Alu edelstahloptik	25542502			
VE 10	32,70 €/St			
< VE	37,61 €/St			

runde Ecken auf Anfrage verfügbar rounded corners available upon request bords arrondis disponible sur demande

PF 862² ⌀3 mm

versenkt gebohrt
countersunk drilled
à percement noyé

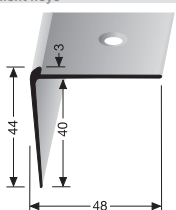

3,0

SBS

VE	10x 2,50 m	10x 1,00 m		
F3 Alu poliert	25622503			
F4 Alu silber	25622504	25621004		
F9 Alu sand	25622509			
VE 10	33,65 €/St	13,90 €/St		
< VE	38,70 €/St	15,99 €/St		
F5 Alu gold	25622505			
F6 Alu bronze	25622506			
F2 Alu edelstahloptik	25622502	25621002		
VE 10	37,90 €/St	15,60 €/St		
< VE	43,59 €/St	17,94 €/St		

²runde Ecken (S. 116–120) round corners (p. 116–120) coins arrondis (p. 116–120)

* Messing-Preise können sich ändern! Brass prices may change! Les prix du laiton peuvent subir des variations!

Treppenkantenprofile

Stair nosings Nez de marches

VE	10 x 2,50 m			
F3 Alu poliert	25612503			
F4 Alu silber	25612504			
F9 Alu sand	25612509			
VE 10	26,55 €/St			
< VE	30,53 €/St			
F5 Alu gold	25612505			
F6 Alu bronze	25612506			
F2 Alu edelstahloptik	25612502			
VE 10	29,45 €/St			
< VE	33,87 €/St			



VE	10 x 2,50 m			
F3 Alu poliert	25632503			
F4 Alu silber	25632504			
F9 Alu sand	25632509			
VE 10	27,30 €/St			
< VE	31,40 €/St			
F5 Alu gold	25632505			
F6 Alu bronze	25632506			
F2 Alu edelstahloptik	25632502			
VE 10	29,85 €/St			
< VE	34,33 €/St			



VE	10 x 2,50 m			
F3 Alu poliert	25642503			
F4 Alu silber	25642504			
F9 Alu sand	25642509			
VE 10	27,85 €/St			
< VE	32,03 €/St			
F5 Alu gold	25642505			
F6 Alu bronze	25642506			
F2 Alu edelstahloptik	25642502			
VE 10	30,15 €/St			
< VE	34,67 €/St			



Treppenkantenprofile

Stair nosings Nez de marches

PF 865 ± 3 mm

versenkt gebohrt
countersunk drilled
à percement noyé

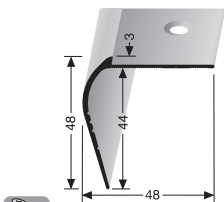

3,0

SBS

VE	6x 2,50 m		
F3 Alu poliert	25652503		
F4 Alu silber	25652504		
F9 Alu sand	25652509		
VE 6	34,80 €/St		
< VE	40,02 €/St		
F5 Alu gold	25652505		
F6 Alu bronze	25652506		
F2 Alu edelstahloptik	25652502		
VE 6	39,35 €/St		
< VE	45,25 €/St		

PF 866 ± 5 mm

versenkt gebohrt
countersunk drilled
à percement noyé

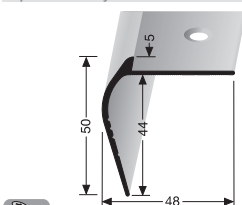

3,0

SBS

VE	6x 2,50 m		
F3 Alu poliert	25662503		
F4 Alu silber	25662504		
F9 Alu sand	25662509		
VE 6	37,25 €/St		
< VE	42,84 €/St		
F5 Alu gold	25662505		
F6 Alu bronze	25662506		
F2 Alu edelstahloptik	25662502		
VE 6	41,55 €/St		
< VE	47,78 €/St		

PF 870² $\pm 2,5$ mm

doppelt versetzt versenkt gebohrt
double offset countersunk drilled
à percement noyé décalé double

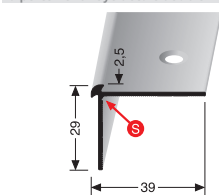

3,0

SBS

S Sollbiegestelle
Predetermined
bending point
Point de pliage

VE	10x 2,50 m	10x 1,00 m	
F3 Alu poliert	25702503		
F4 Alu silber	25702504	25701004	
F9 Alu sand	25702509		
VE 10	29,10 €/St	12,10 €/St	
< VE	33,47 €/St	13,92 €/St	
F5 Alu gold	25702505		
F6 Alu bronze	25702506		
F2 Alu edelstahloptik	25702502	25701002	
VE 10	32,35 €/St	13,40 €/St	
< VE	37,20 €/St	15,41 €/St	
F16 Alu pulver. schwarz	25702516		NEU-NEW NOUVEAU
VE 10	36,35 €/St		
< VE	41,80 €/St		

Montagevideos
installation videos
vidéos d'installation

PF 870/871ec



PF 870/871ev



²runde Ecken (S. 116–120) round corners (p. 116–120)
coins arrondis (p. 116–120)

Treppenkantenprofile

Stair nosings Nez de marches

VE	10x 2,50 m	10x 1,00 m		
F3 Alu poliert	25712503			
F4 Alu silber	25712504	25711004		
F9 Alu sand	25712509			
VE 10	29,45 €/St	12,35 €/St		
< VE	33,87 €/St	14,20 €/St		
F5 Alu gold	25712505			
F6 Alu bronze	25712506			
F2 Alu edelstahloptik	25712502	25711002		
VE 10	32,70 €/St	13,50 €/St		
< VE	37,61 €/St	15,53 €/St		
F16 Alu pulver. schwarz	25712516			
VE 10	36,65 €/St			
< VE	42,15 €/St			

PF 871² ∅3 mm

doppelt versetzt versenkt gebohrt
double offset countersunk drilled
à perçement noyé décalé double

Sollbiegestelle
Predetermined bending point
Point de pliage

SBS

VE	10x 2,50 m			
F3 Alu poliert	25722503			
F4 Alu silber	25722504			
F9 Alu sand	25722509			
VE 10	30,50 €/St			
< VE	35,08 €/St			
F5 Alu gold	25722505			
F6 Alu bronze	25722506			
F2 Alu edelstahloptik	25722502			
VE 10	33,40 €/St			
< VE	38,41 €/St			

PF 872 ∅4 mm

doppelt versetzt versenkt gebohrt
double offset countersunk drilled
à perçement noyé décalé double

Sollbiegestelle
Predetermined bending point
Point de pliage

SBS

VE	10x 2,50 m	10x 1,00 m		
F3 Alu poliert	25732503			
F4 Alu silber	25732504	25731004		
F9 Alu sand	25732509			
VE 10	32,15 €/St	13,30 €/St		
< VE	36,97 €/St	15,30 €/St		
F5 Alu gold	25732505			
F6 Alu bronze	25732506			
F2 Alu edelstahloptik	25732502	25731002		
VE 10	34,35 €/St	14,15 €/St		
< VE	39,50 €/St	16,27 €/St		

PF 873 ∅5 mm

doppelt versetzt versenkt gebohrt
double offset countersunk drilled
à perçement noyé décalé double

Sollbiegestelle
Predetermined bending point
Point de pliage

SBS

Treppenkantenprofile

Stair nosings Nez de marches

PF 874 \varnothing 6,5 mm

doppelt versetzt versenkt gebohrt
double offset countersunk drilled
à percement noyé décalé double

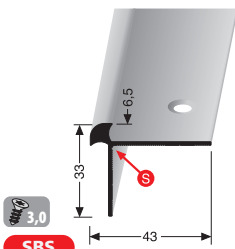

SBS

S Sollbiegestelle
Predetermined
bending point Point de pliage

PF 875 \varnothing 8 mm

doppelt versetzt versenkt gebohrt
double offset countersunk drilled
à percement noyé décalé double

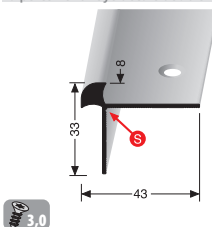

SBS

S Sollbiegestelle
Predetermined
bending point
Point de pliage

PF 876 \varnothing 11 mm

NEU-NEW
NOUVEAU

doppelt versetzt versenkt gebohrt
double offset countersunk drilled
à percement noyé décalé double

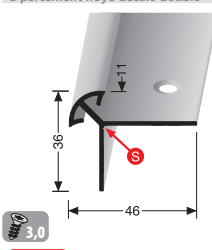

SBS

PF 879 \varnothing 15 mm

NEU-NEW
NOUVEAU

doppelt versetzt versenkt gebohrt
double offset countersunk drilled
à percement noyé décalé double

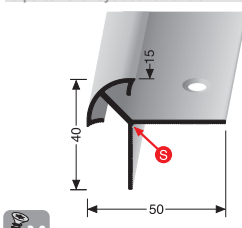

SBS

VE	10x 2,50 m	10x 1,00 m
F4 Alu silber	25742504	25741004
F9 Alu sand	25742509	
VE 10	34,50 €/St	14,30 €/St
< VE	39,68 €/St	16,45 €/St
F5 Alu gold	25742505	
F6 Alu bronze	25742506	
F2 Alu edelstahloptik	25742502	25741002
VE 10	38,25 €/St	15,70 €/St
< VE	43,99 €/St	18,06 €/St

VE	10x 2,50 m	
F4 Alu silber	25752504	
F9 Alu sand	25752509	
VE 10	38,05 €/St	
< VE	43,76 €/St	
F5 Alu gold	25752505	
F6 Alu bronze	25752506	
F2 Alu edelstahloptik	25752502	
VE 10	41,55 €/St	
< VE	47,78 €/St	
F16 Alu pulver. schwarz	25752516	NEU-NEW NOUVEAU
VE 10	43,95 €/St	
< VE	50,54 €/St	

VE	10x 2,50 m	
F4 Alu silber	25762504	
VE 10	39,60 €/St	
< VE	45,54 €/St	
F2 Alu edelstahloptik	25762502	
VE 10	44,00 €/St	
< VE	50,60 €/St	
F16 Alu pulver. schwarz	25762516	
VE 10	46,50 €/St	
< VE	53,48 €/St	

Ecklösungen für offene Stufen auf Anfrage erhältlich
Corner solutions for open steps available on request
Solutions d'angle pour marches ouvertes disponibles sur demande

VE	10x 2,50 m	
F4 Alu silber	25792504	
VE 10	44,80 €/St	
< VE	51,52 €/St	
F2 Alu edelstahloptik	25792502	
VE 10	49,75 €/St	
< VE	57,21 €/St	
F16 Alu pulver. schwarz	25792516	
VE 10	52,20 €/St	
< VE	60,03 €/St	

Ecklösungen für offene Stufen auf Anfrage erhältlich
Corner solutions for open steps available on request
Solutions d'angle pour marches ouvertes disponibles sur demande

Treppenkantenprofile

Stair nosings Nez de marches

VE	10 x 2,50 m			
F4 Alu silber	78772504			
VE 10	23,30 €/St			
< VE	26,80 €/St			
F2 Alu edelstahloptik	78772502			
VE 10	25,85 €/St			
< VE	29,73 €/St			

PF 877 IW \varnothing 3,2 mm

doppelt versetzt versenkt gebohrt
double offset countersunk drilled
à perçement noyé décalé double

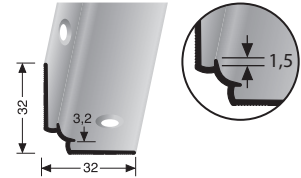

3,0

SBS

VE	10 x 2,50 m			
F4 Alu silber	78702504			
F9 Alu sand	78702509			
VE 10	22,85 €/St			
< VE	26,28 €/St			
F5 Alu gold	78702505			
F6 Alu bronze	78702506			
F2 Alu edelstahloptik	78702502			
VE 10	25,15 €/St			
< VE	28,92 €/St			

PF 870 IW \varnothing 2,5 mm

doppelt versetzt versenkt gebohrt
double offset countersunk drilled
à perçement noyé décalé double

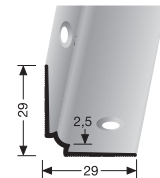

3,0

SBS

VE	10 x 2,50 m			
F4 Alu silber	78712504			
F9 Alu sand	78712509			
VE 10	22,95 €/St			
< VE	26,39 €/St			
F5 Alu gold	78712505			
F6 Alu bronze	78712506			
F2 Alu edelstahloptik	78712502			
VE 10	25,50 €/St			
< VE	29,33 €/St			

PF 871 IW \varnothing 3 mm

doppelt versetzt versenkt gebohrt
double offset countersunk drilled
à perçement noyé décalé double

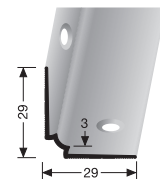

3,0

SBS

PF 870/871ec



PF 870/871ev



Montagevideos
installation videos
vidéos d'installation

Treppenkantenprofile mit runder Ecke

Stair nosings with round corner Nez de marches avec coin arrondi

PF 859 EC $\varnothing 2,5$ mm

doppelt versenkt gebohrt
double countersunk drilled
double à percement noyé

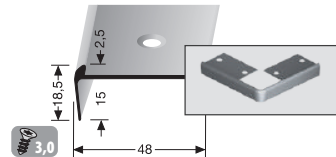

SBS-O

VE	1x		
30 x 30 cm			
F4 Alu silber	25590004		
VE 1	75,40 €/St		

PF 859 EC-L $\varnothing 2,5$ mm

doppelt versenkt gebohrt
double countersunk drilled
double à percement noyé

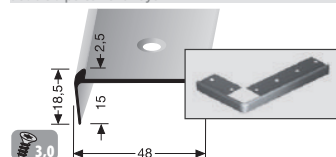

SBS-O

VE	1x	VE	1x
30 x 100 cm		30 x 150 cm	
F4 Alu silber	25596104	F4 Alu silber	25596154
VE 1	90,85 €/St	VE 1	97,60 €/St

runde Ecken, links rounded corners, left bords arrondis, gauche

PF 859 EC-R $\varnothing 2,5$ mm

doppelt versenkt gebohrt
double countersunk drilled
double à percement noyé

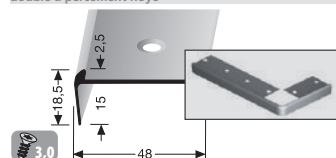

SBS-O

VE	1x	VE	1x
100 x 30 cm		150 x 30 cm	
F4 Alu silber	25597104	F4 Alu silber	25597154
VE 1	90,85 €/St	VE 1	97,60 €/St

runde Ecken, rechts rounded corners, right bords arrondis, droit

PF 860 EC $\varnothing 3$ mm

doppelt versenkt gebohrt
double countersunk drilled
double à percement noyé

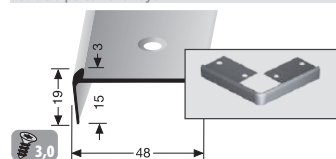

SBS-O

VE	1x		
30 x 30 cm			
F4 Alu silber	25600004		
VE 1	76,75 €/St		

PF 860 EC-L $\varnothing 3$ mm

doppelt versenkt gebohrt
double countersunk drilled
double à percement noyé

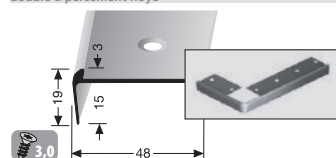

SBS-O

VE	1x	VE	1x
30 x 100 cm		30 x 150 cm	
F4 Alu silber	25606104	F4 Alu silber	25606154
VE 1	92,30 €/St	VE 1	98,90 €/St

runde Ecken, links rounded corners, left bords arrondis, gauche

Montagevideo
installation video
vidéo d'installation



Treppenkantenprofile mit runder Ecke

Stair nosings with round corner Nez de marches avec coin arrondi

VE	1x	VE	1x
100 x 30 cm		150 x 30 cm	
F4 Alu silber	25607104	F4 Alu silber	25607154
VE 1	92,30 €/St	VE 1	98,90 €/St

runde Ecken, rechts rounded corners, right bords arrondis, droit

VE	1x
30 x 30 cm	
F4 Alu silber	25620004
VE 1	79,40 €/St

VE	1x	VE	1x
30 x 100 cm		30 x 150 cm	
F4 Alu silber	25626104	F4 Alu silber	25626154
VE 1	94,95 €/St	VE 1	101,60 €/St

runde Ecken, links rounded corners, left bords arrondis, gauche

VE	1x	VE	1x
30 x 100 cm		30 x 150 cm	
F4 Alu silber	25627104	F4 Alu silber	25627154
VE 1	94,95 €/St	VE 1	101,60 €/St

runde Ecken, rechts rounded corners, right bords arrondis, droit

VE	1x
30 x 30 cm	
F4 Alu silber	25700004
VE 1	76,75 €/St

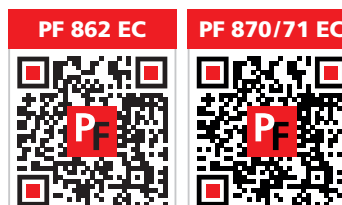
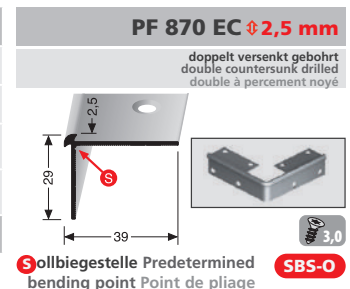
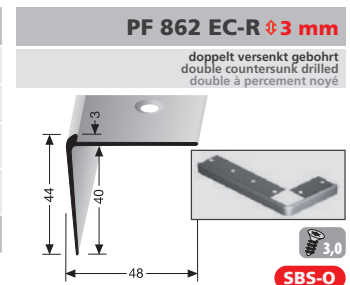
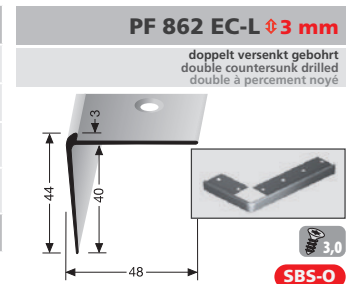
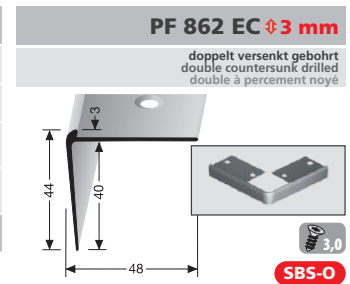
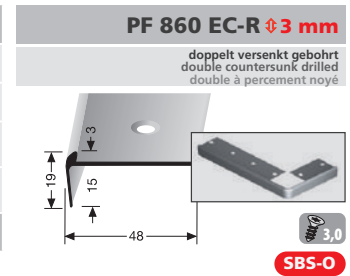

Montagevideos
installation videos
vidéos d'installation

Treppenkantenprofile mit runder Ecke

Stair nosings with round corner Nez de marches avec coin arrondi

PF 870 EC-L $\varnothing 2,5\text{ mm}$

doppelt versenkt gebohrt
double countersunk drilled
double à percement noyé

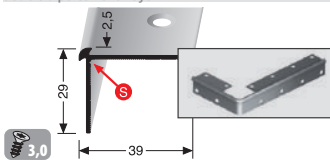

SBS-O

VE	1x	VE	1x
30 x 100 cm		30 x 150 cm	
F4 Alu silber	25708104	F4 Alu silber	25708154
VE 1	92,30 €/St	VE 1	98,90 €/St

runde Ecken, links rounded corners, left bords arrondis, gauche

PF 870 EC-R $\varnothing 2,5\text{ mm}$

doppelt versenkt gebohrt
double countersunk drilled
double à percement noyé

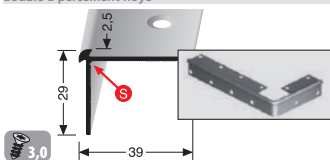

SBS-O

VE	1x	VE	1x
100 x 30 cm		150 x 30 cm	
F4 Alu silber	25709104	F4 Alu silber	25709154
VE 1	92,30 €/St	VE 1	98,90 €/St

runde Ecken, rechts rounded corners, right bords arrondis, droit

PF 870 EV $\varnothing 2,5\text{ mm}$

doppelt versenkt gebohrt, zweiteilig
double countersunk drilled, two-part
double à percement noyé, en deux parties

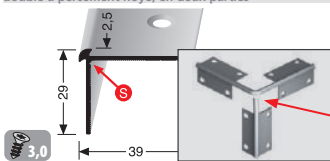

SBS-O

VE	1x	VE	1x
30 x 30 x 20 cm			
F4 Alu silber	25700104		
VE 1	109,70 €/St		

besteht aus 2 Teilen, consists of 2 parts, se compose de 2 parties

PF 870 EV-L $\varnothing 2,5\text{ mm}$

doppelt versenkt gebohrt, zweiteilig
double countersunk drilled, two-part
double à percement noyé, en deux parties

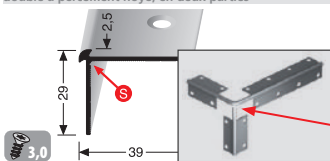

SBS-O

VE	1x	VE	1x
30 x 100 cm x 20 cm		30 x 150 cm x 20 cm	
F4 Alu silber	25706104	F4 Alu silber	25706154
VE 1	125,15 €/St	VE 1	131,90 €/St

besteht aus 2 Teilen, consists of 2 parts, se compose de 2 parties

runde Ecken, links rounded corners, left bords arrondis, gauche

PF 870 EV-R $\varnothing 2,5\text{ mm}$

doppelt versenkt gebohrt, zweiteilig
double countersunk drilled, two-part
double à percement noyé, en deux parties

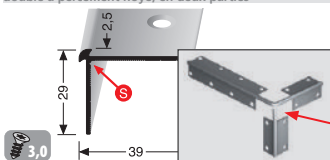

SBS-O

VE	1x	VE	1x
100 x 30 x 20 cm		150 x 30 cm x 20 cm	
F4 Alu silber	25707104	F4 Alu silber	25707154
VE 1	125,15 €/St	VE 1	131,90 €/St

besteht aus 2 Teilen, consists of 2 parts, se compose de 2 parties

runde Ecken, rechts rounded corners, right bords arrondis, droit

Montagevideos
installation videos
vidéos d'installation



Treppenkantenprofile mit runder Ecke

Stair nosings with round corner Nez de marches avec coin arrondi

VE	1x			
30 x 30 cm				
F4 Alu silber	25710004			
VE 1	78,10 €/St			

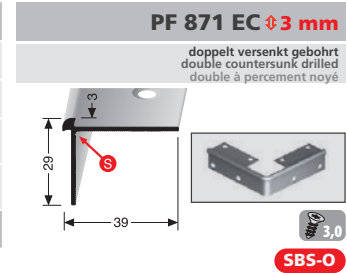

VE	1x	VE	1x
30 x 100 cm		30 x 150 cm	
F4 Alu silber	25718104	F4 Alu silber	25718154
VE 1	93,55 €/St	VE 1	100,30 €/St

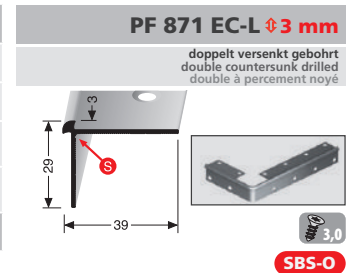

runde Ecken, links rounded corners, left bords arrondis, gauche

VE	1x	VE	1x
100 x 30 cm		150 x 30 cm	
F4 Alu silber	25719104	F4 Alu silber	25719154
VE 1	93,55 €/St	VE 1	100,30 €/St

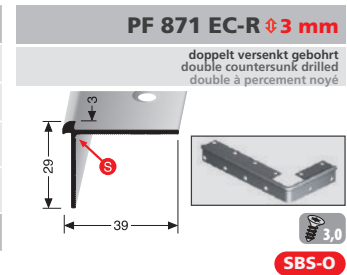

runde Ecken, rechts rounded corners, right bords arrondis, droit

VE	1x			
30 x 30 x 20 cm				
F4 Alu silber	25710104			
VE 1	111,10 €/St			
besteht aus 2 Teilen, consists of 2 parts, se compose de 2 parties				

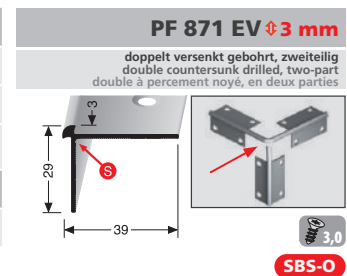

VE	1x	VE	1x	
30 x 100 x 20 cm		30 x 150 x 20 cm		
F4 Alu silber	25716104	F4 Alu silber	25716154	
VE 1	126,55 €/St	VE 1	133,30 €/St	
besteht aus 2 Teilen, consists of 2 parts, se compose de 2 parties				

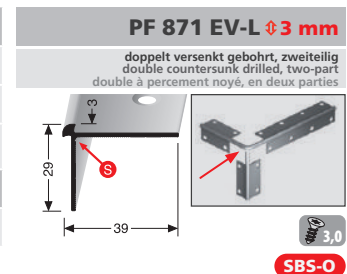

runde Ecken, links rounded corners, left bords arrondis, gauche

Sollbiegestelle Predetermined bending point Point de pliage

Treppenkantenprofile mit runder Ecke

Stair nosings with round corner Nez de marches avec coin arrondi

PF 871 EV-R $\diamond 3$ mm

doppelt versenkt gebohrt, zweiteilig
double countersunk drilled, two-part
double à percement noyé, en deux parties

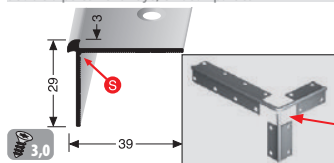

SBS-O

VE	1x	VE	1x
100 x 30 x 20 cm		150 x 30 x 20 cm	
F4 Alu silber	25717104	F4 Alu silber	25717154
VE 1	126,55 €/St	VE 1	133,30 €/St

besteht aus 2 Teilen, consists of 2 parts, se compose de 2 parties

runde Ecken, rechts rounded corners, right bords arrondis, droit

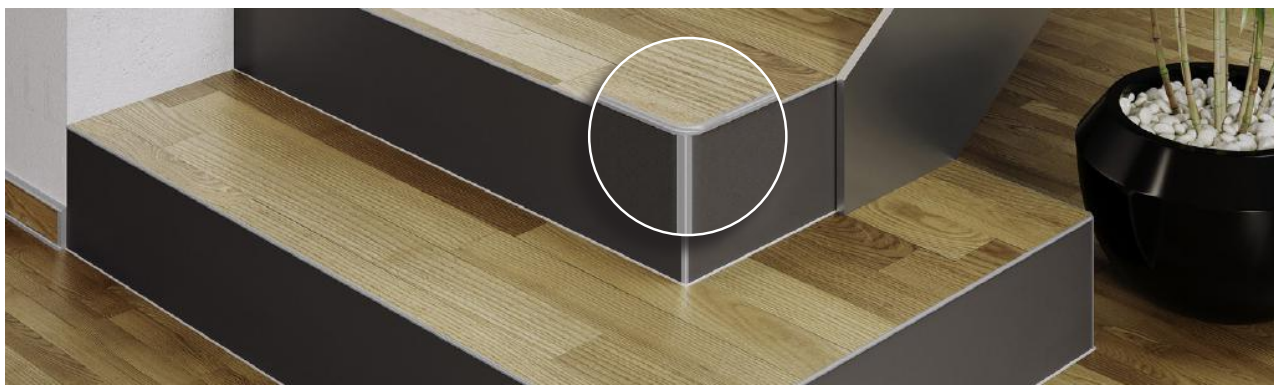

für for pour PF 845

versenkt gebohrt
countersunk drilled
à percement noyé

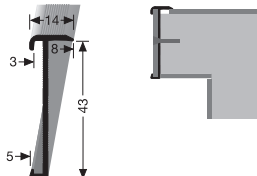

PF 845 EC $\diamond 3$ mm

Außenecke 90°
external corner 90°
angle extérieur 90°



3,0

SBS

VE	1x
30 x 30 cm	
F4 Alu silber	25450004
VE 1	79,30 €/St

PF 845 EC-L $\diamond 3$ mm

linke Ecke
corner left
angle gauche



3,0

SBS

VE	1x
30 x 100 cm	
F4 Alu silber	25456104
VE 1	92,50 €/St

PF 845 EC-R $\diamond 3$ mm

rechte Ecke
corner right
angle droit



3,0

SBS

VE	1x
100 x 30 cm	
F4 Alu silber	25457104
VE 1	92,50 €/St

für for pour PF 846

versenkt gebohrt
countersunk drilled
à percement noyé

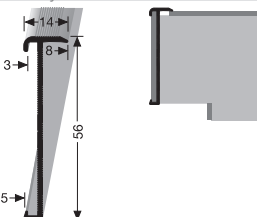

PF 846 EC $\diamond 3$ mm

Außenecke 90°
external corner 90°
angle extérieur 90°

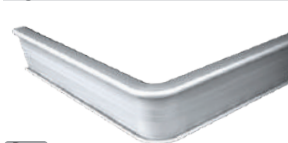

3,0

SBS

VE	1x
30 x 30 cm	
F4 Alu silber	25460004
VE 1	79,30 €/St

Treppenkantenprofile mit runder Ecke

Stair nosings with round corner Nez de marches avec coin arrondi

VE	1x
30 x 100 cm	
F4 Alu silber	25466104
VE 1	92,50 €/St

PF 846 EC-L ± 3 mm
linke Ecke
corner left
angle gauche



 3,0

SBS

VE	1x
100 x 30 cm	
F4 Alu silber	25467104
VE 1	92,50 €/St

PF 846 EC-R ± 3 mm
rechte Ecke
corner right
angle droit



 3,0

SBS



PF 845 / 846



Montagevideo
installation video
vidéo d'installation